



INTEGRITY
ARCHITECTURAL
MILLWORK, INC.

Quality Architectural
Wood Products

2503 Taylor Street
Omaha, NE 68111

(402) 451-4110

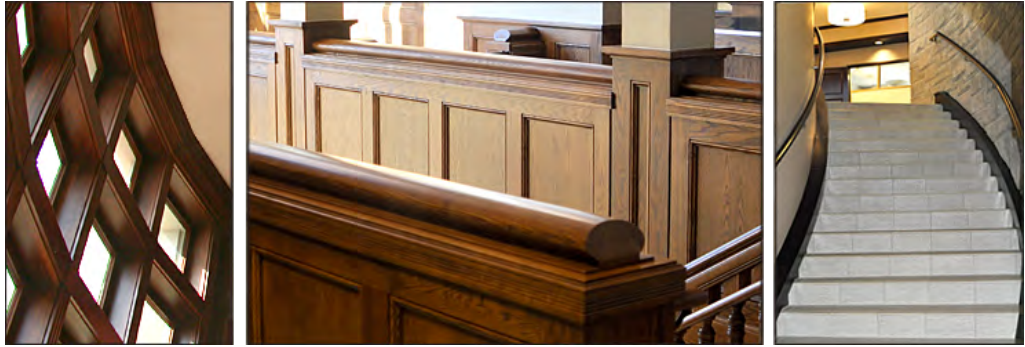

Architectural Mouldings

We currently have over 1000 different profiles in Integrity Architectural Millwork's moulding library. We can also replicate mouldings for historical restoration projects using a drawing or sample as a pattern.

We keep Maple, Birch, Cherry, Red Oak, Poplar, Alder, Mahogany, Hickory, Walnut and Ash on hand. Hundreds, if not thousands, of other species can also be ordered. Either way, we prepare the materials you need to your specifications.

View by Category

If you know the type of moulding you need, visit the links below to see all our profiles by size.

- **Base** | Sizes from 1" to 4" as well as variable widths | [GO](#)
- **Cabinet Moulding** | Sizes range from less than 1" to over 3" | [GO](#)
- **Casing** | Profiles from 1" to 5+" | [GO](#)
- **Chair Rail** | Widths from 1" to more than 5" | [GO](#)
- **Crown Moulding** | Numerous choices from 1" to 7+" | [GO](#)
- **Flooring** | Widths from 1 7/8" to 3 1/2" | [GO](#)
- **Paneling** | Sizes range from 2" to nearly 7" | [GO](#)
- **Railings** | Profile sizes from 1" to 5+" | [GO](#)
- **Miscellaneous** | Cove, quarter round and more | [GO](#)

View by Product Number

Already know the product number you need? View its profile or download a CAD file | [GO](#)

We Are Here to Help

If you'd like to discuss your project needs, call us at (402) 451-4110 or [contact us now.](#)

Product images are generally to scale but are not shown at actual size.



INTEGRITY
ARCHITECTURAL
MILLWORK, INC.

Quality Architectural
Wood Products

2503 Taylor Street
Omaha, NE 68111

(402) 451-4110



Base Mouldings

Base mouldings add interest when you choose from one of the hundreds of profiles available from Integrity Architectural Millwork. While we keep Maple, Birch, Cherry, Red Oak and Poplar on hand, hundreds, if not thousands, of other species can also be ordered. All millwork is prepared to your specifications.

Sizes: Under 1-4 inch | Variable (You specify the height desired.)

1-4" Base Mouldings

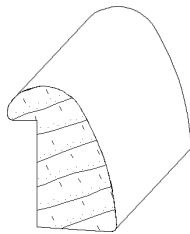

IH-509
3/4 x 1
base moulding

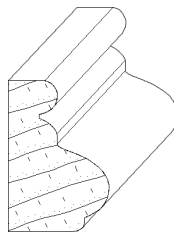

IH-590
3/4 x 1-1/8
base moulding

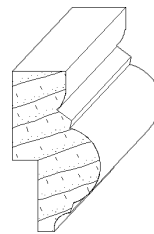

IH-567
3/4 x 1-5/16
base moulding

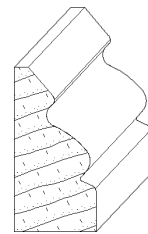

IH-584
3/4 x 1-9/16
base moulding

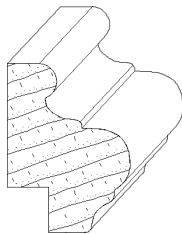

IH-535
1-3/16 x 1-5/8
base moulding

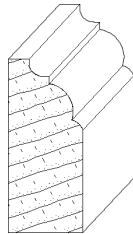

IH-1589
3/4 x 1-3/4
base moulding

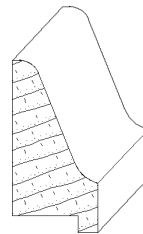

IH-569
13/16 x 1-13/16
base moulding

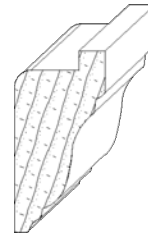

IH-1575
1 x 2
base moulding

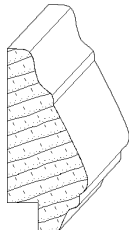

IH-519 (Cap for 518)
1 x 2-1/4
base moulding

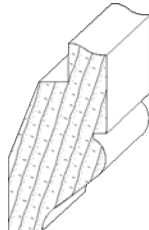

IH-1574
1-1/4 x 2-3/8
base moulding

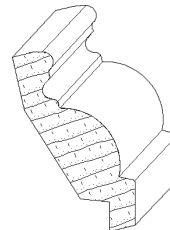

IH-1552
3/4 x 2-7/16
base moulding



IH-595
3/4 x 2-1/2
base moulding



INTEGRITY
ARCHITECTURAL
MILLWORK, INC.

Quality Architectural
Wood Products

2503 Taylor Street
Omaha, NE 68111

(402) 451-4110

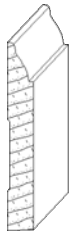

IH-582
3/8 x 2-3/4
base moulding

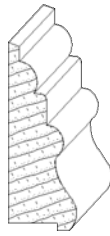

IH-587
1 x 2-3/4
base moulding



IH-551 (Cap for 526)
3/4 x 2-13/16
base moulding

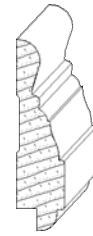

IH-1539
3/4 x 3
base moulding

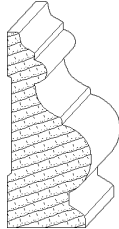

IH-593
1-1/2 x 3-1/2
base moulding

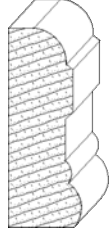

IH-1573
1-3/8 x 3-3/4
base moulding



IH-1561
3/4 x 3-13/16
base moulding



IH-1567
1/2 x 4
base moulding

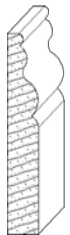

IH-1570
5/8 x 4
base moulding

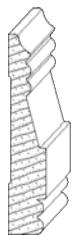

IH-1555
3/4 x 4-3/16
base moulding

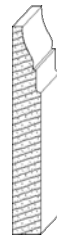

IH-1565
3/4 x 5-1/2
base moulding

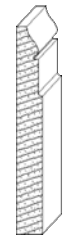

IH-1568
11/16 x 5-1/2
base moulding

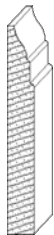

IH-1566
3/4 x 5-13/16
base moulding



INTEGRITY
ARCHITECTURAL
MILLWORK, INC.

Quality Architectural
Wood Products

2503 Taylor Street
Omaha, NE 68111

(402) 451-4110

Variable Base Mouldings (You specify the height desired.)

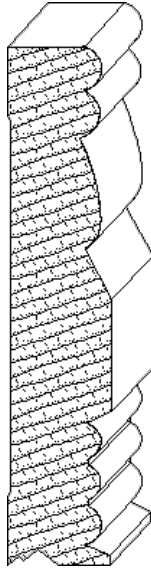

IH-500
1-5/16 x Variable
base moulding

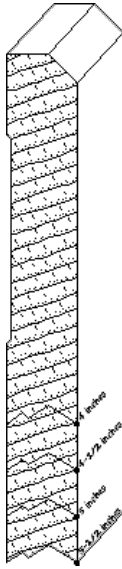

IH-501
3/4 x Variable
base moulding

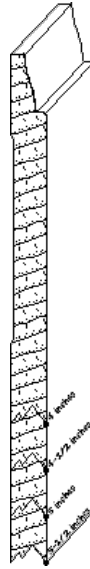

IH-502
3/8 x Variable
base moulding

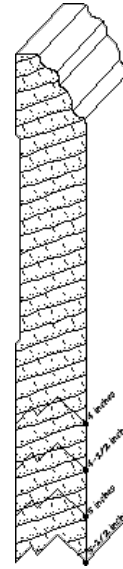

IH-503
3/4 x Variable
base moulding

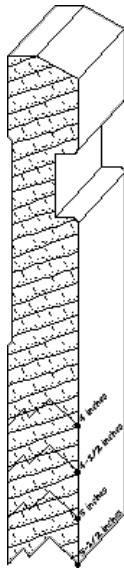

IH-504
3/4 x Variable
base moulding

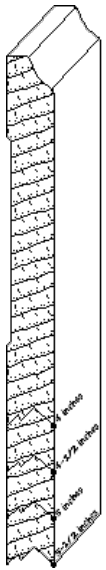

IH-505
1/2 x Variable
base moulding

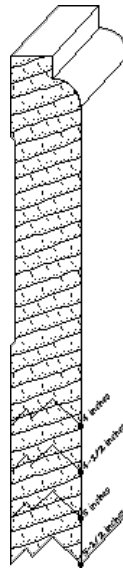

IH-506
3/4 x Variable
base moulding

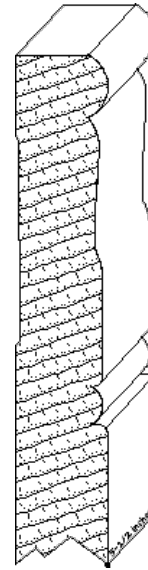

IH-507
1 x Variable
base moulding



INTEGRITY
ARCHITECTURAL
MILLWORK, INC.

Quality Architectural
Wood Products

2503 Taylor Street
Omaha, NE 68111

(402) 451-4110

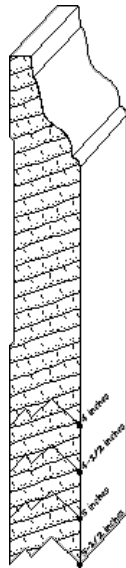

IH-508
3/4 x Variable
base moulding

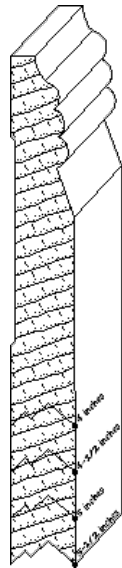

IH-510
11/16 x Variable
base moulding

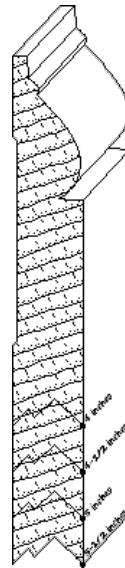

IH-511
3/4 x Variable
base moulding

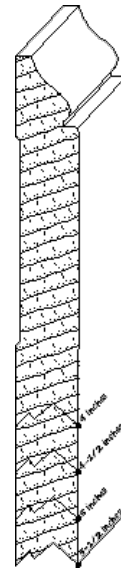

IH-512
11/16 x Variable
base moulding

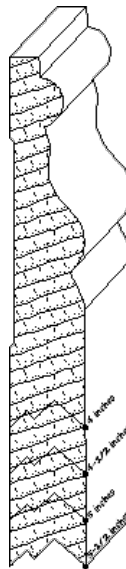

IH-513
13/16 x Variable
base moulding

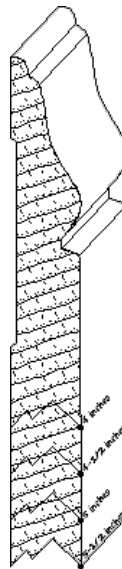

IH-514
3/4 x Variable
base moulding

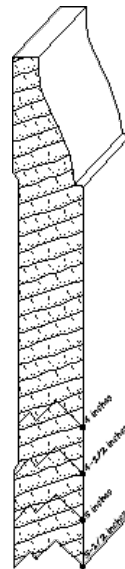

IH-515
3/4 x Variable
base moulding

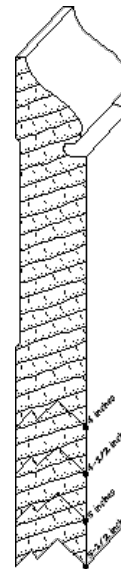

IH-516
3/4 x Variable
base moulding



INTEGRITY
ARCHITECTURAL
MILLWORK, INC.

Quality Architectural
Wood Products

2503 Taylor Street
Omaha, NE 68111

(402) 451-4110

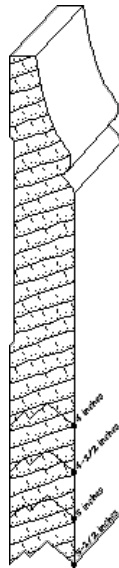

IH-517
11/16 x Variable
base moulding

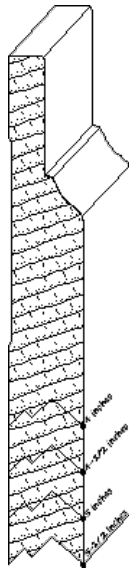

IH-518
13/16 x Variable
base moulding

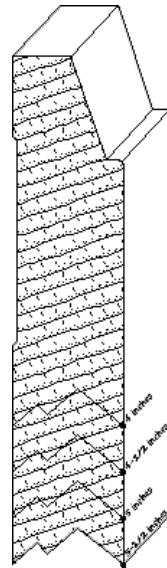

IH-520
1-3/16 x Variable
base moulding

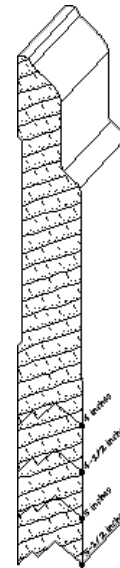

IH-521
11/16 x Variable
base moulding

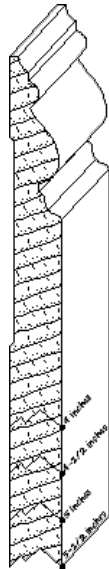

IH-522
9/16 x Variable
base moulding

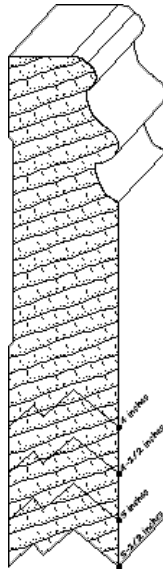

IH-523
1-3/16 x Variable
base moulding

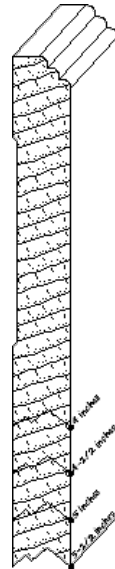

IH-524
5/8 x Variable
base moulding

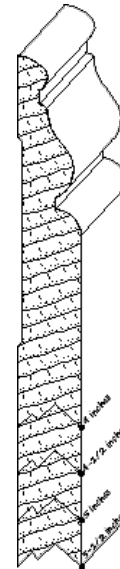

IH-525
11/16 x Variable
base moulding



INTEGRITY
ARCHITECTURAL
MILLWORK, INC.

Quality Architectural
Wood Products

2503 Taylor Street
Omaha, NE 68111

(402) 451-4110

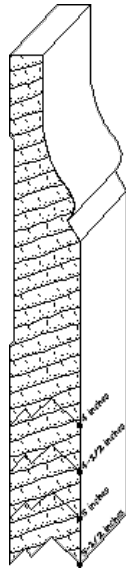

IH-526
3/4 x Variable
base moulding

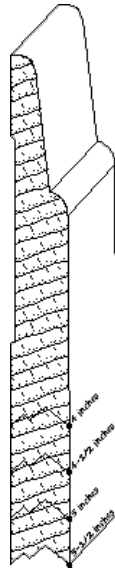

IH-527
5/8 x Variable
base moulding

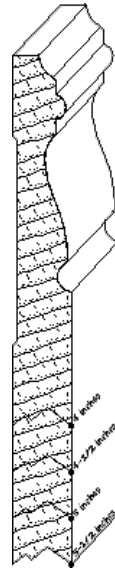

IH-528
5/8 x Variable
base moulding

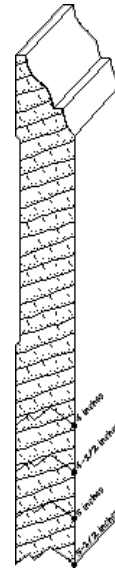

IH-529
5/8 x Variable
base moulding

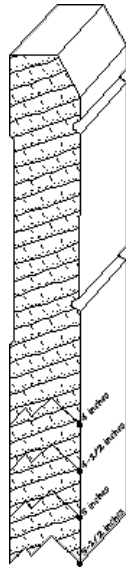

IH-530
3/4 x Variable
base moulding

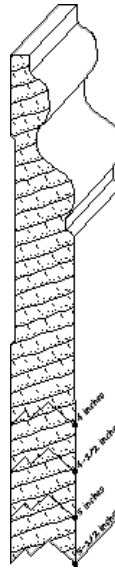

IH-531
11/16 x Variable
base moulding

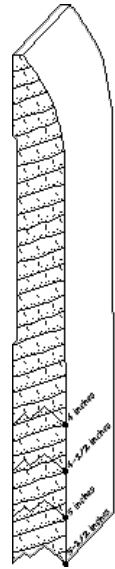

IH-532
9/16 x Variable
base moulding

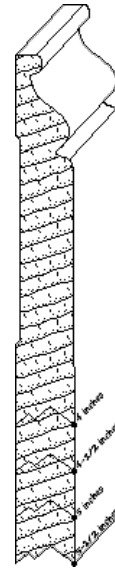

IH-533
5/8 x Variable
base moulding



INTEGRITY
ARCHITECTURAL
MILLWORK, INC.

Quality Architectural
Wood Products

2503 Taylor Street
Omaha, NE 68111

(402) 451-4110

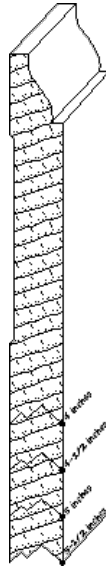

IH-534
9/16 x Variable
base moulding

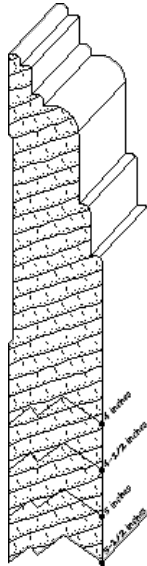

IH-537
1 x Variable
base moulding

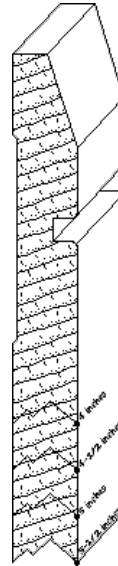

IH-538
11/16 x Variable
base moulding

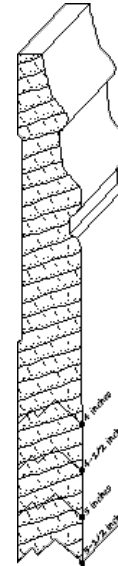

IH-540
11/16 x Variable
base moulding

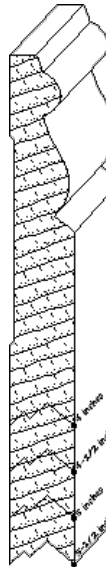

IH-541
11/16 x Variable
base moulding

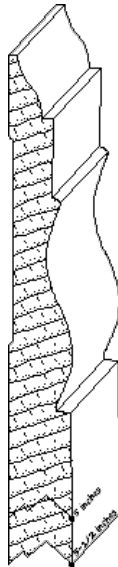

IH-543
11/16 x Variable
base moulding

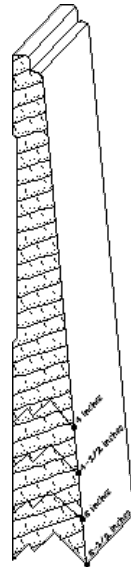

IH-544
3/4 x Variable
base moulding

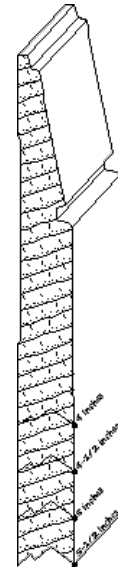

IH-545
5/8 x Variable
base moulding



INTEGRITY
ARCHITECTURAL
MILLWORK, INC.

Quality Architectural
Wood Products

2503 Taylor Street
Omaha, NE 68111

(402) 451-4110

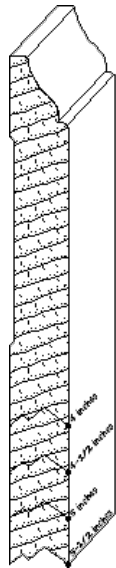

IH-546
5/8 x Variable
base moulding



IH-547
9/16 x Variable
base moulding

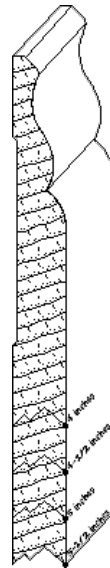

IH-548
9/16 x Variable
base moulding

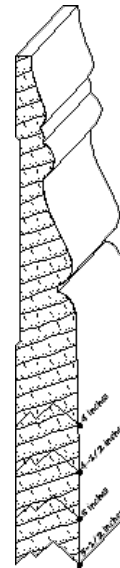

IH-549
11/16 x Variable
base moulding

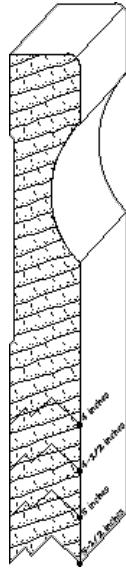

IH-550
3/4 x Variable
base moulding

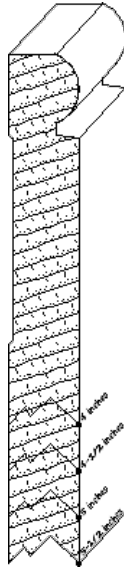

IH-552
3/4 x Variable
base moulding

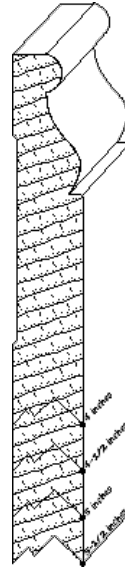

IH-553
3/4 x Variable
base moulding

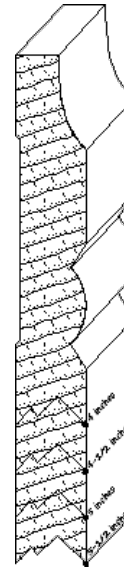

IH-554
3/4 x Variable
base moulding



INTEGRITY
ARCHITECTURAL
MILLWORK, INC.

Quality Architectural
Wood Products

2503 Taylor Street
Omaha, NE 68111

(402) 451-4110

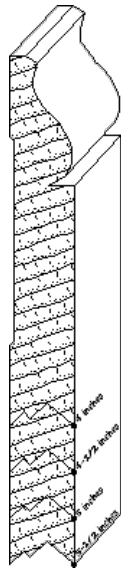

IH-555
11/16 x Variable
base moulding

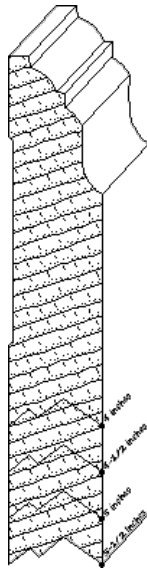

IH-557
1 x Variable
base moulding

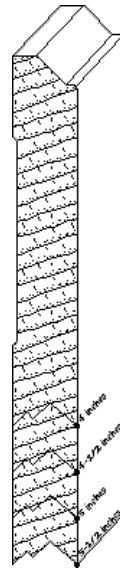

IH-558
11/16 x Variable
base moulding

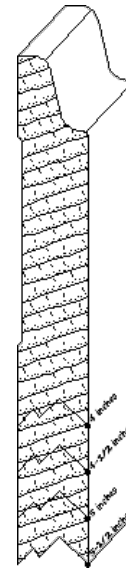

IH-559
11/16 x Variable
base moulding

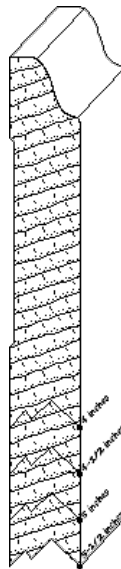

IH-560
3/4 x Variable
base moulding

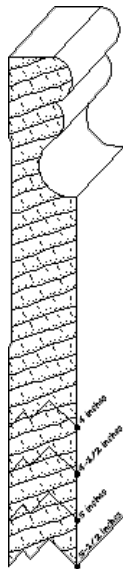

IH-561
3/4 x Variable
base moulding

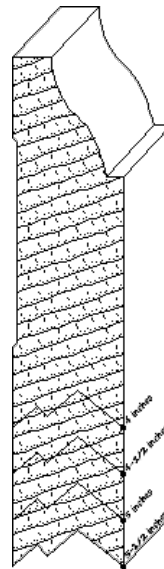

IH-562
1-13/16 x Variable
base moulding

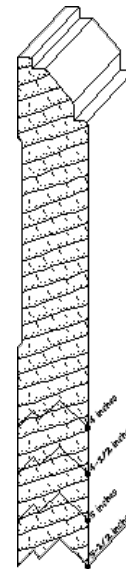

IH-563
3/4 x Variable
base moulding



INTEGRITY
ARCHITECTURAL
MILLWORK, INC.

Quality Architectural
Wood Products

2503 Taylor Street
Omaha, NE 68111

(402) 451-4110

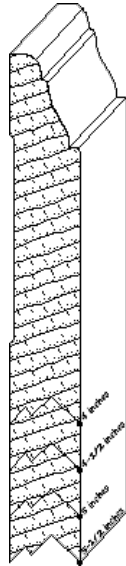

IH-564
3/4 x Variable
base moulding

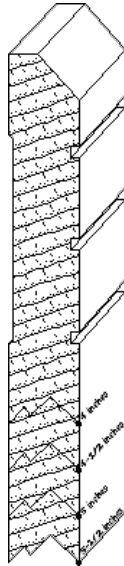

IH-565
3/4 x Variable
base moulding

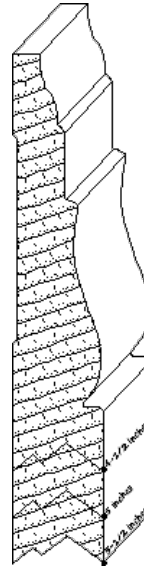

IH-566
1 x Variable
base moulding

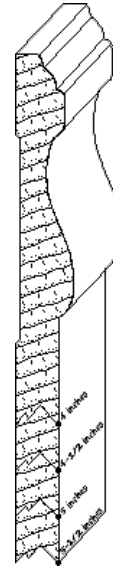

IH-568
5/8 x Variable
base moulding

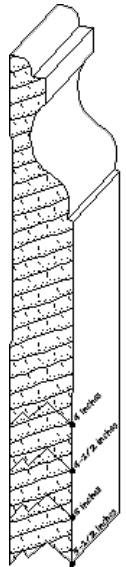

IH-570
11/16 x Variable
base moulding

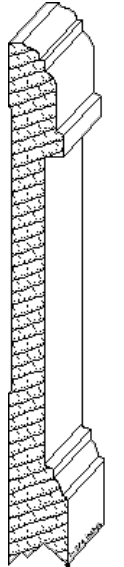

IH-571
13/16 x Variable
base moulding

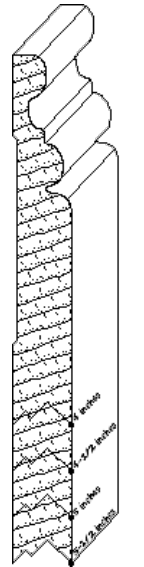

IH-572
5/8 x Variable
base moulding

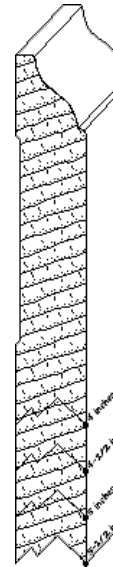

IH-573
3/4 x Variable
base moulding



INTEGRITY
ARCHITECTURAL
MILLWORK, INC.

Quality Architectural
Wood Products

2503 Taylor Street
Omaha, NE 68111

(402) 451-4110



IH-574
5/8 x Variable
base moulding

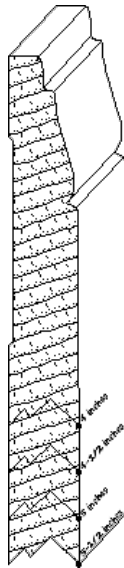

IH-575
3/4 x Variable
base moulding

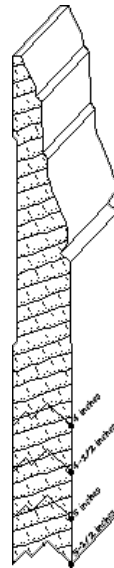

IH-576
5/8 x Variable
base moulding

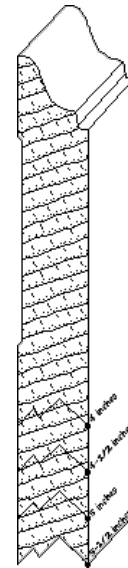

IH-577
3/4 x Variable
base moulding

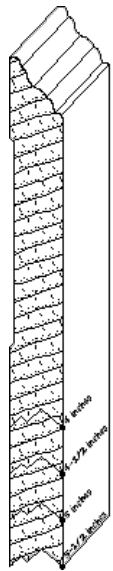

IH-578
9/16 x Variable
base moulding

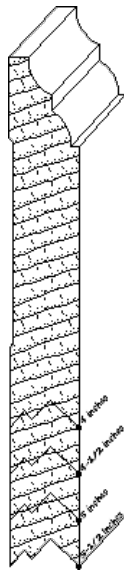

IH-579
3/4 x Variable
base moulding

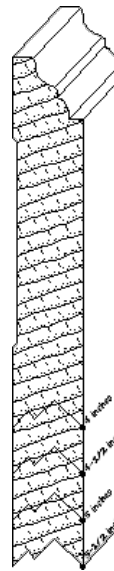

IH-580
3/4 x Variable
base moulding

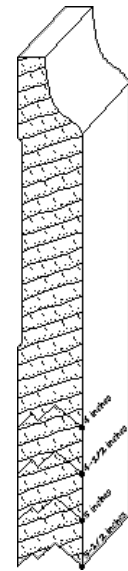

IH-581
11/16 x Variable
base moulding



INTEGRITY
ARCHITECTURAL
MILLWORK, INC.

Quality Architectural
Wood Products

2503 Taylor Street
Omaha, NE 68111

(402) 451-4110

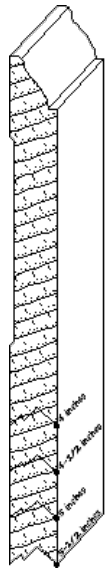

IH-583
1/2 x Variable
base moulding

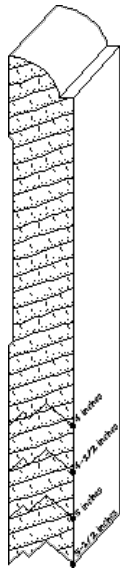

IH-585
11/16 x Variable
base moulding

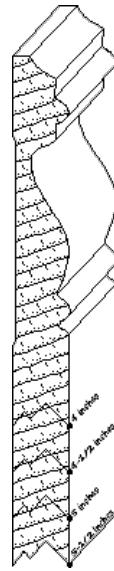

IH-586
5/8 x Variable
base moulding

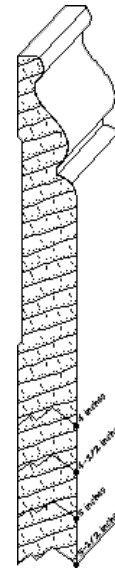

IH-588
5/8 x Variable
base moulding

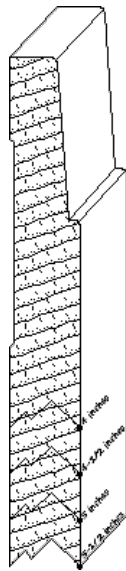

IH-589
3/4 x Variable
base moulding

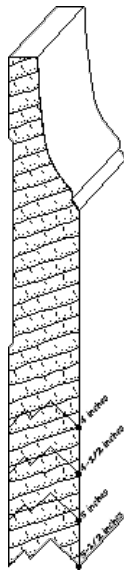

IH-591
3/4 x Variable
base moulding

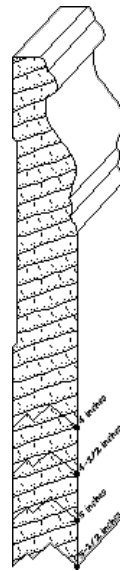

IH-592
11/16 x Variable
base moulding

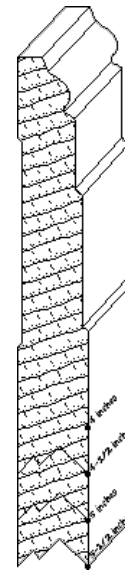

IH-594
3/4 x Variable
base moulding



INTEGRITY
ARCHITECTURAL
MILLWORK, INC.

Quality Architectural
Wood Products

2503 Taylor Street
Omaha, NE 68111

(402) 451-4110

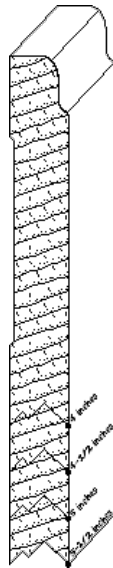

IH-596
5/8 x Variable
base moulding

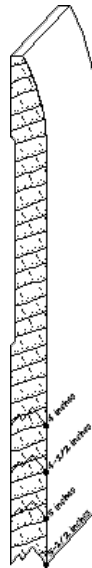

IH-597
3/8 x Variable
base moulding

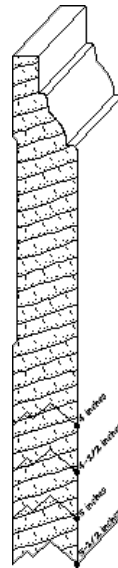

IH-598
11/16 x Variable
base moulding

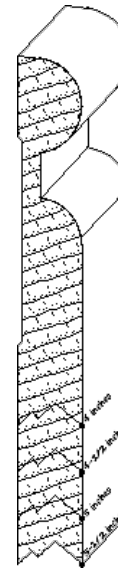

IH-599
11/16 x Variable
base moulding

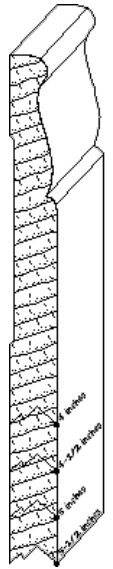

IH-1502
1/2 x Variable
base moulding

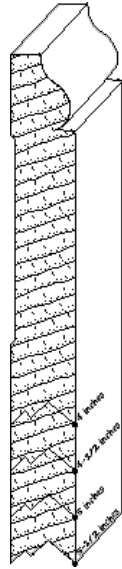

IH-1503
11/16 x Variable
base moulding

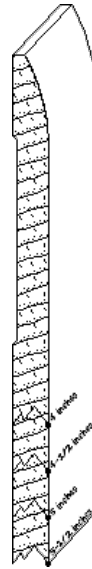

IH-1504
3/8 x Variable
base moulding

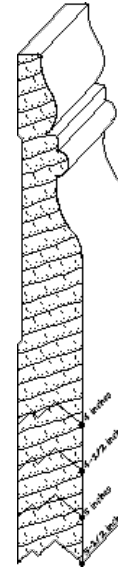

IH-1505
11/16 x Variable
base moulding



INTEGRITY
ARCHITECTURAL
MILLWORK, INC.

Quality Architectural
Wood Products

2503 Taylor Street
Omaha, NE 68111

(402) 451-4110

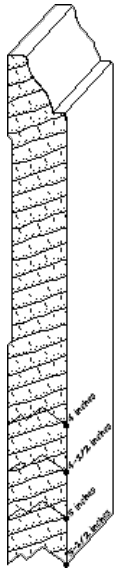

IH-1506
5/8 x Variable
base moulding



IH-1507
5/8 x Variable
base moulding

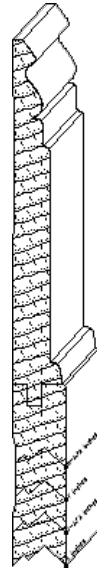

IH-1508
13/16 x Variable
base moulding

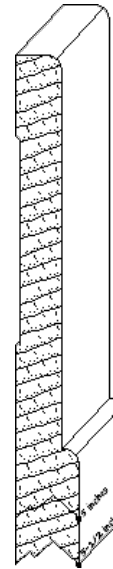

IH-1509
11/16 x Variable
base moulding

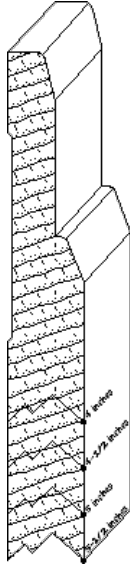

IH-1510
13/16 x Variable
base moulding

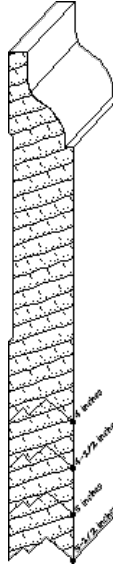

IH-1511
11/16 x Variable
base moulding

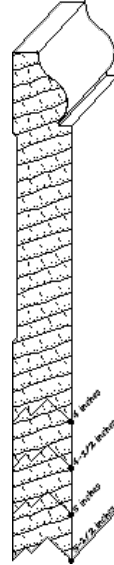

IH-1512
5/8 x Variable
base moulding

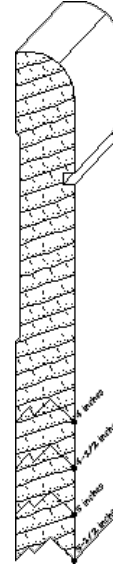

IH-1513
5/8 x Variable
base moulding



INTEGRITY
ARCHITECTURAL
MILLWORK, INC.

Quality Architectural
Wood Products

2503 Taylor Street
Omaha, NE 68111

(402) 451-4110

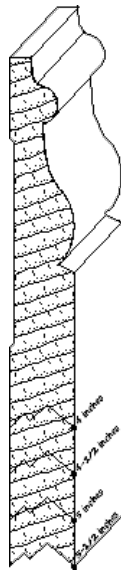

IH-1514
11/16 x Variable
base moulding

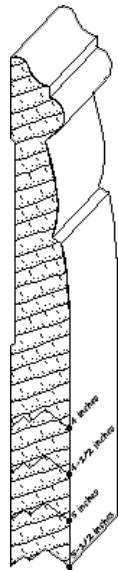

IH-1515
5/8 x Variable
base moulding

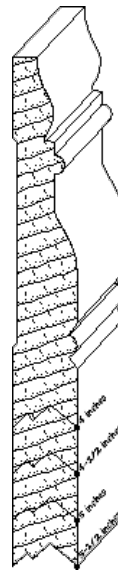

IH-1516
11/16 x Variable
base moulding

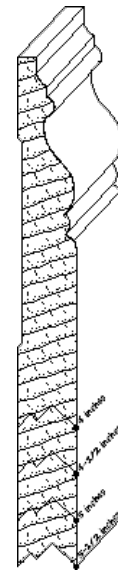

IH-1517
5/8 x Variable
base moulding

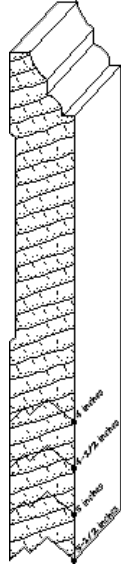

IH-1518
11/16 x Variable
base moulding

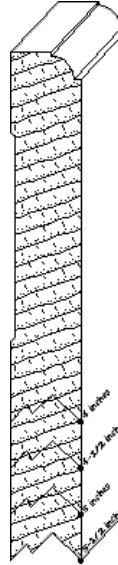

IH-1519
3/4 x Variable
base moulding

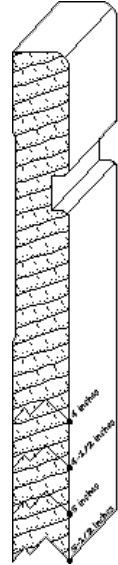

IH-1520
5/8 x Variable
base moulding

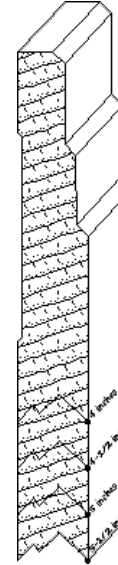

IH-1521
3/4 x Variable
base moulding



INTEGRITY
ARCHITECTURAL
MILLWORK, INC.

Quality Architectural
Wood Products

2503 Taylor Street
Omaha, NE 68111

(402) 451-4110

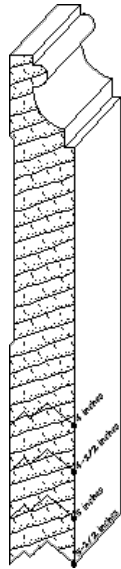

IH-1522
11/16 x Variable
base moulding

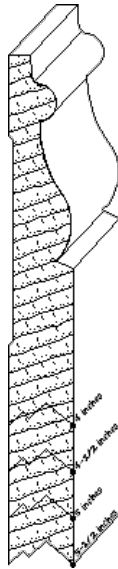

IH-1523
11/16 x Variable
base moulding

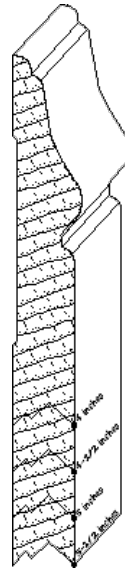

IH-1524
3/4 x Variable
base moulding

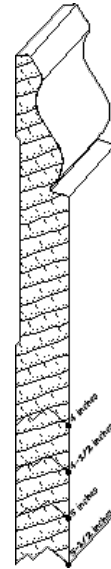

IH-1525
9/16 x Variable
base moulding

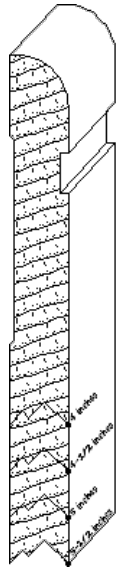

IH-1526
5/8 x Variable
base moulding

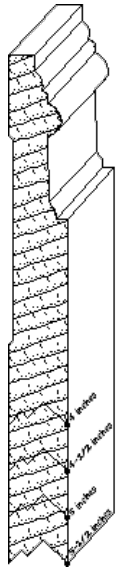

IH-1527
5/8 x Variable
base moulding

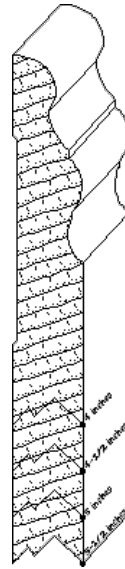

IH-1528
3/4 x Variable
base moulding

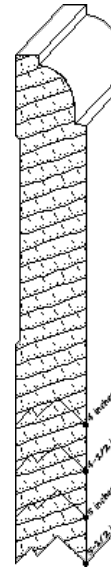

IH-1529
3/4 x Variable
base moulding



INTEGRITY
ARCHITECTURAL
MILLWORK, INC.

Quality Architectural
Wood Products

2503 Taylor Street
Omaha, NE 68111

(402) 451-4110

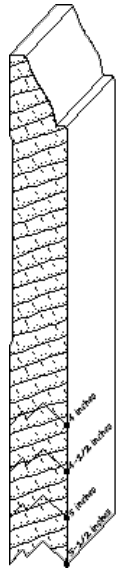

IH-1530
5/8 x Variable
base moulding

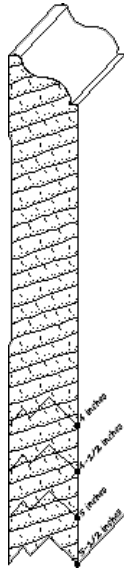

IH-1531
3/4 x Variable
base moulding

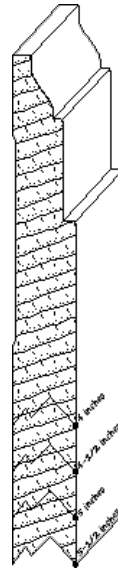

IH-1533
11/16 x Variable
base moulding

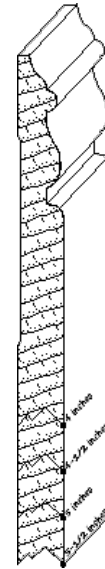

IH-1534
1/2 x Variable
base moulding

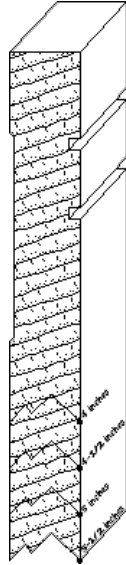

IH-1535
3/4 x Variable
base moulding

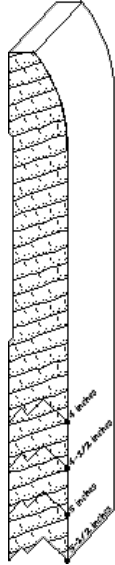

IH-1536
5/8 x Variable
base moulding

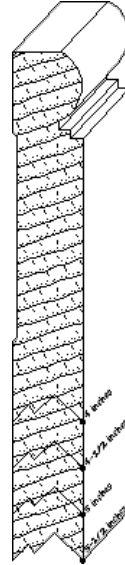

IH-1537
3/4 x Variable
base moulding

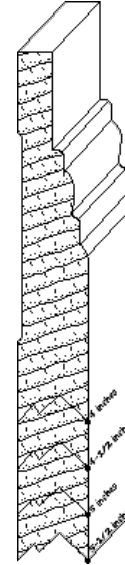

IH-1538
3/4 x Variable
base moulding



INTEGRITY
ARCHITECTURAL
MILLWORK, INC.

Quality Architectural
Wood Products

2503 Taylor Street
Omaha, NE 68111

(402) 451-4110

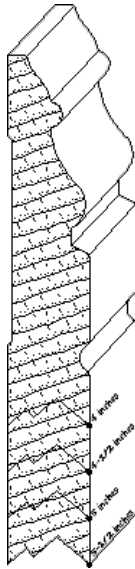

IH-1540
7/8 x Variable
base moulding

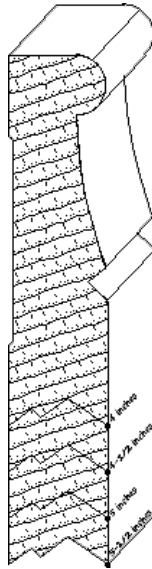

IH-1541
1-1/16 x Variable
base moulding

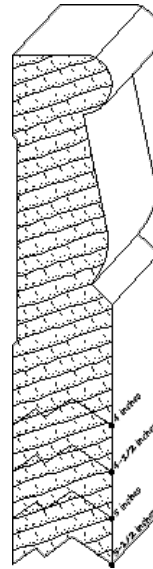

IH-1542
1-1/16 x Variable
base moulding

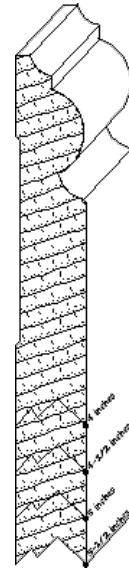

IH-1543
3/4 x Variable
base moulding

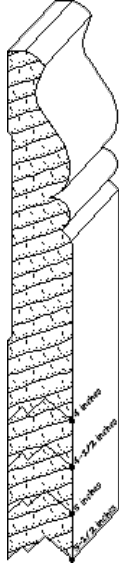

IH-1544
11/16 x Variable
base moulding

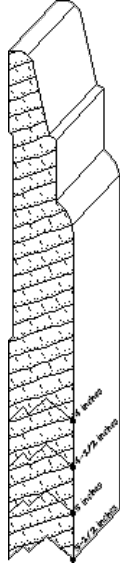

IH-1545
11/16 x Variable
base moulding

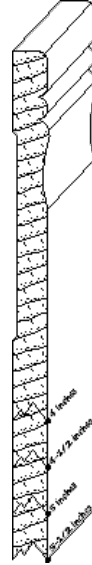

IH-1546
3/8 x Variable
base moulding

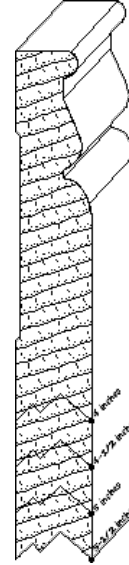

IH-1547
13/16 x Variable
base moulding



INTEGRITY
ARCHITECTURAL
MILLWORK, INC.

Quality Architectural
Wood Products

2503 Taylor Street
Omaha, NE 68111

(402) 451-4110

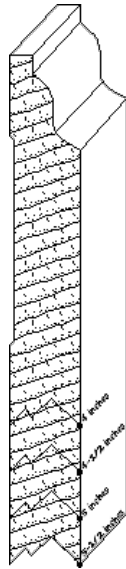

IH-1548
3/4 x Variable
base moulding

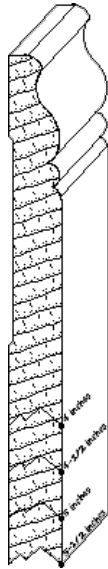

IH-1549
9/16 x Variable
base moulding

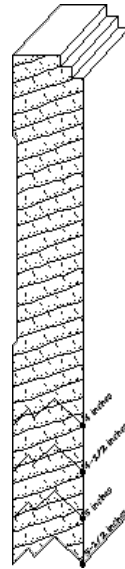

IH-1550
3/4 x Variable
base moulding

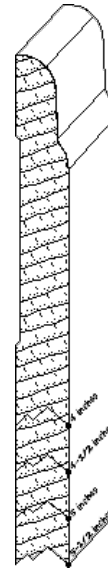

IH-1551
9/16 x Variable
base moulding

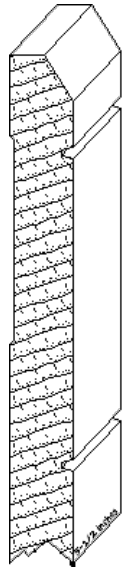

IH-1553
11/16 x Variable
base moulding

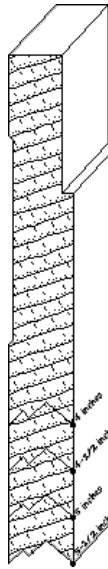

IH-1554
11/16 x Variable
base moulding

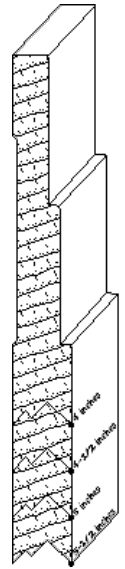

IH-1556
5/8 x Variable
base moulding

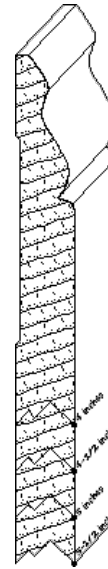

IH-1557
5/8 x Variable
base moulding



INTEGRITY
ARCHITECTURAL
MILLWORK, INC.

Quality Architectural
Wood Products

2503 Taylor Street
Omaha, NE 68111

(402) 451-4110

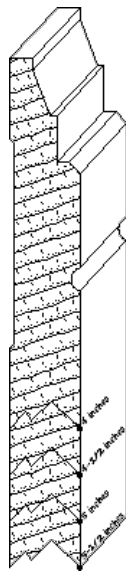

IH-1558
3/4 x Variable
base moulding

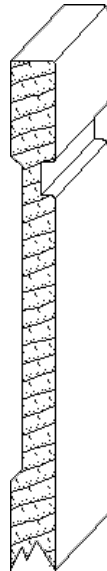

IH-1559
7/16 x variable
base moulding

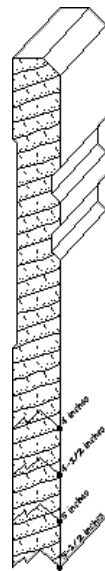

IH-1560
1/2 x Variable
base moulding

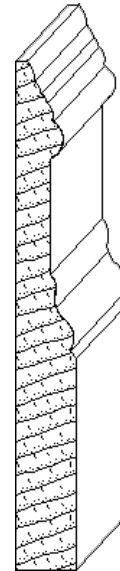

IH-1569
9/16 x variable
base moulding

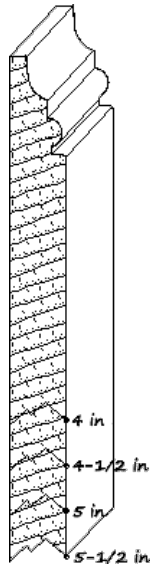

IH-1571
5/8 x variable
base moulding

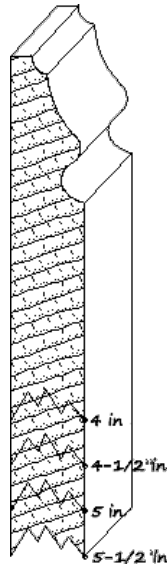

IH-1572
13/16 x variable
base moulding

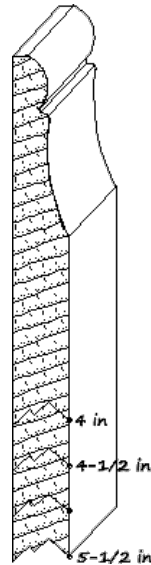

IH-1578
5/8 x variable
base moulding

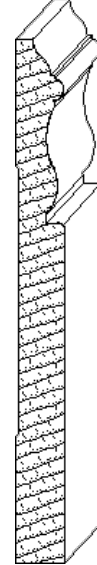

IH-1579
11/16 x variable
base moulding



INTEGRITY
ARCHITECTURAL
MILLWORK, INC.

Quality Architectural
Wood Products

2503 Taylor Street
Omaha, NE 68111

(402) 451-4110

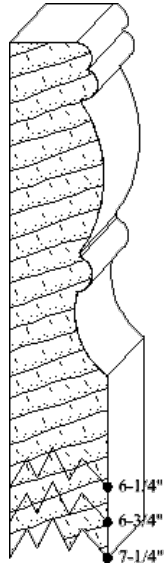

IH-1580
1-3/8 x variable
base moulding

Base Moulding in the Size, Profile and Species You Need

To discuss your project needs, please call us at (402) 451-4110 or [contact us online](#).

Product images are generally to scale but are not shown at actual size.



INTEGRITY
ARCHITECTURAL
MILLWORK, INC.

Quality Architectural
Wood Products

2503 Taylor Street
Omaha, NE 68111

(402) 451-4110



Cabinet Mouldings

Considering Integrity Architectural Millwork's hundreds of cabinet moulding profiles and the wood species available, the possibilities are nearly endless. We keep Maple, Birch, Cherry, Red Oak and Poplar on hand, hundreds, if not thousands, of other species can also be ordered. All millwork is prepared to your specifications.

Sizes: [Under 1 inch](#) | [1 inch](#) | [1 1/2 inch](#) | [2 inch](#) | [3+ inch](#)

Under 1" Cabinet Moulding

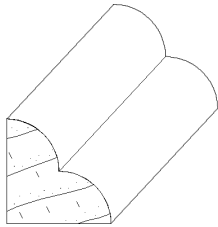

IH-1218
1/2 x 1/2
cabinet moulding

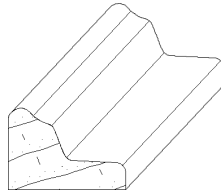

IH-218
7/16 x 5/8
cabinet moulding

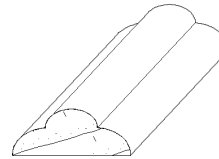

IH-265
1/4 x 5/8
cabinet moulding

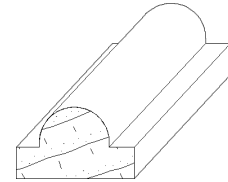

IH-283
3/8 x 5/8
cabinet moulding

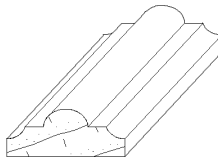

IH-289
1/4 x 5/8
cabinet moulding

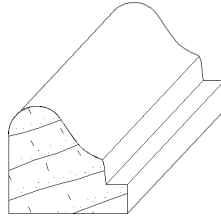

IH-297
9/16 x 5/8
cabinet moulding

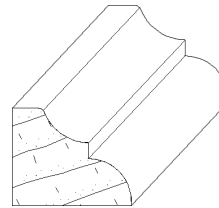

IH-1207
1/2 x 5/8
cabinet moulding

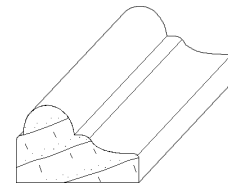

IH-267
7/16 x 11/16
cabinet moulding

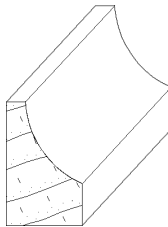

IH-1211
7/16 x 11/16
cabinet moulding

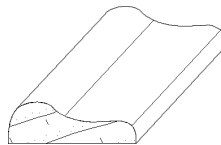

IH-206
1/4 x 3/4
cabinet moulding

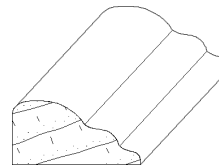

IH-217
3/8 x 3/4
cabinet moulding

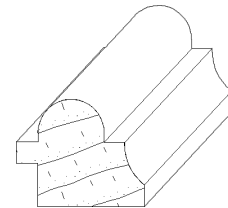

IH-284
5/8 x 3/4
cabinet moulding



INTEGRITY
ARCHITECTURAL
MILLWORK, INC.

Quality Architectural
Wood Products

2503 Taylor Street
Omaha, NE 68111

(402) 451-4110

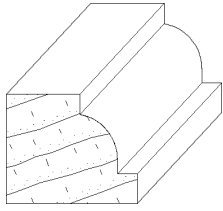

IH-1206
5/8 x 3/4
cabinet moulding

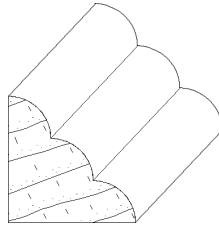

IH-1219
3/4 x 3/4
cabinet moulding

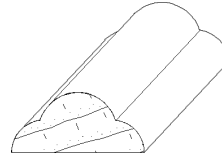

IH-208
3/8 x 13/16
cabinet moulding

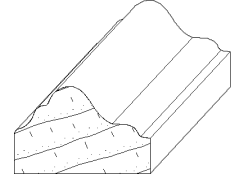

IH-205
9/16 x 7/8
cabinet moulding

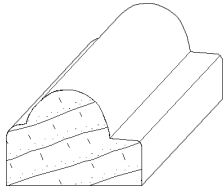

IH-213
5/8 x 7/8
cabinet moulding

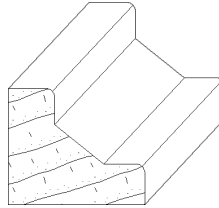

IH-233
3/4 x 7/8
cabinet moulding

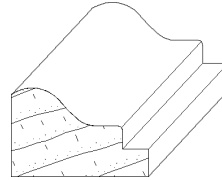

IH-296
9/16 x 7/8
cabinet moulding

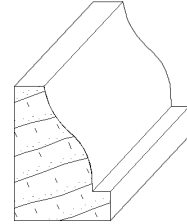

IH-1215
5/8 x 7/8
cabinet moulding



INTEGRITY
ARCHITECTURAL
MILLWORK, INC.

Quality Architectural
Wood Products

2503 Taylor Street
Omaha, NE 68111

(402) 451-4110

1" Cabinet Moulding

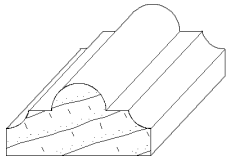

IH-277
1/2 x 1
cabinet moulding

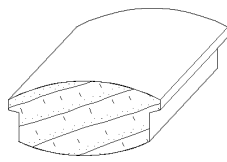

IH-286
9/16 x 1
cabinet moulding

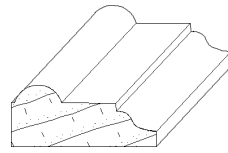

IH-1205
7/16 x 1
cabinet moulding

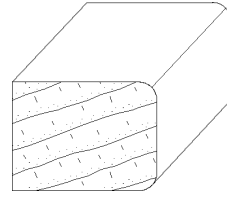

IH-1217
3/4 x 1
cabinet moulding

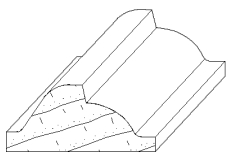

IH-1208
1/2 x 1-1/16
cabinet moulding

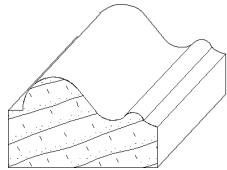

IH-214
11/16 x 1-1/8
cabinet moulding

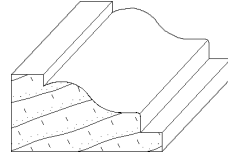

IH-295
9/16 x 1-1/8
cabinet moulding

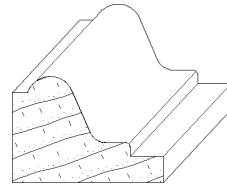

IH-299
13/16 x 1-1/8
cabinet moulding

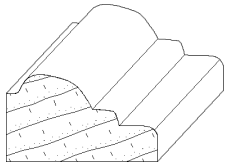

IH-226
11/16 x 1-3/16
cabinet moulding

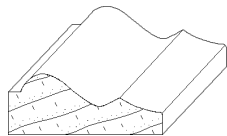

IH-204
1/2 x 1-1/4
cabinet moulding

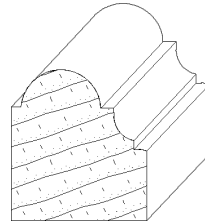

IH-221
1-1/8 x 1-1/4
cabinet moulding

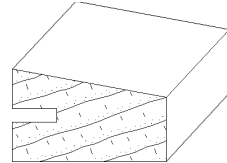

IH-247
3/4 x 1-1/4
cabinet moulding

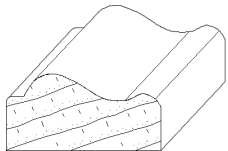

IH-266
5/8 x 1-1/4
cabinet moulding

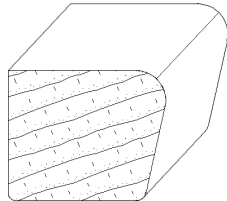

IH-298
1-1/16 x 1-1/4
cabinet moulding

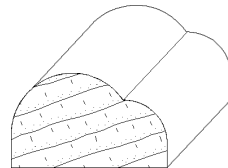

IH-1201
3/4 x 1-1/4
cabinet moulding

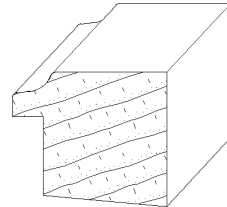

IH-1214
1-1/16 x 1-1/4
cabinet moulding

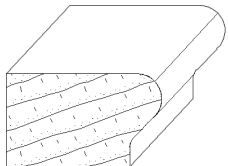

IH-1223
3/4 x 1-1/4
cabinet moulding



IH-1228
7/16 x 1-5/16
cabinet moulding

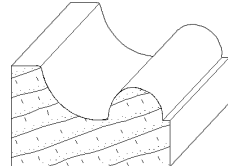

IH-228
7/8 x 1-3/8
cabinet moulding

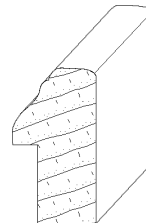

IH-257
3/4 x 1-3/8
cabinet moulding



INTEGRITY
ARCHITECTURAL
MILLWORK, INC.

Quality Architectural
Wood Products

2503 Taylor Street
Omaha, NE 68111

(402) 451-4110

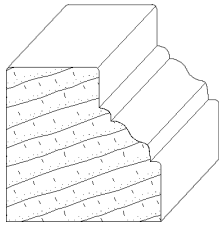

IH-260
1-3/8 x 1-3/8
cabinet moulding

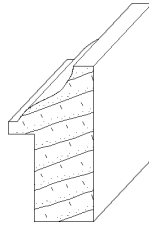

IH-269
3/4 x 1-3/8
cabinet moulding

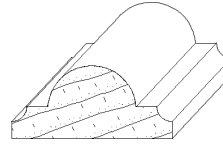

IH-278
9/16 x 1-3/8
cabinet moulding

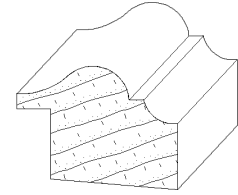

IH-1234
1-1/16 x 1-3/8
cabinet moulding

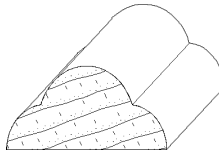

IH-209
3/4 x 1-7/16
cabinet moulding

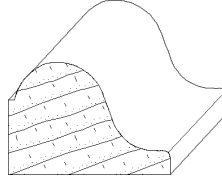

IH-288
1 x 1-7/16
cabinet moulding

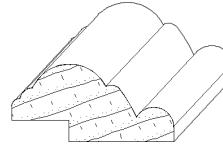

IH-1226
11/16 x 1-7/16
cabinet moulding



INTEGRITY
ARCHITECTURAL
MILLWORK, INC.

Quality Architectural
Wood Products

2503 Taylor Street
Omaha, NE 68111

(402) 451-4110

1 1/2" Cabinet Moulding

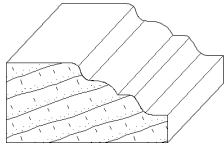

IH-200
3/4 x 1-1/2
cabinet moulding

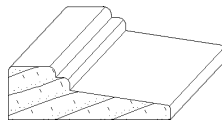

IH-219
1/2 x 1-1/2
cabinet moulding

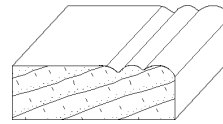

IH-220
1/2 x 1-1/2
cabinet moulding

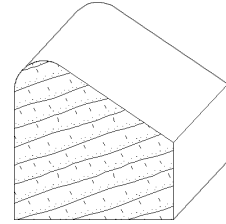

IH-230
1-1/2 x 1-1/2
cabinet moulding

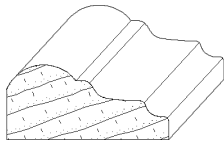

IH-231
11/16 x 1-1/2
cabinet moulding

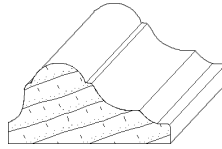

IH-237
3/4 x 1-1/2
cabinet moulding

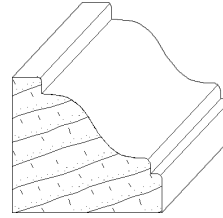

IH-252
1 x 1-1/2
cabinet moulding

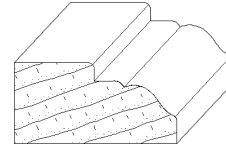

IH-253
3/4 x 1-1/2
cabinet moulding

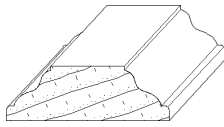

IH-261
1/2 x 1-1/2
cabinet moulding

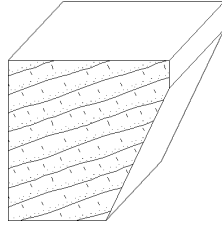

IH-262
1-1/2 x 1-1/2
cabinet moulding

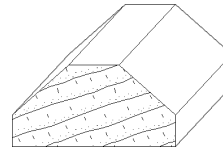

IH-263
3/4 x 1-1/2
cabinet moulding

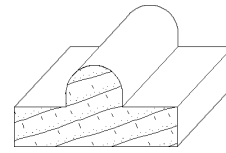

IH-290
3/4 x 1-1/2
cabinet moulding



IH-1200
5/16 x 1-1/2
cabinet moulding

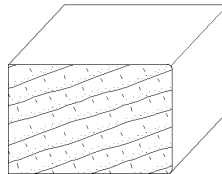

IH-1220
1 x 1-1/2
cabinet moulding

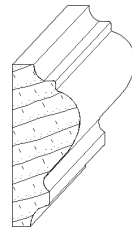

IH-1230
5/8 x 1-1/2
cabinet moulding

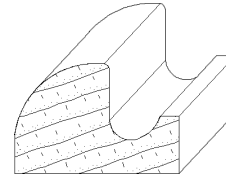

IH-1233
1 x 1-1/2
cabinet moulding

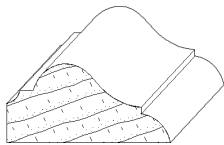

IH-202
3/4 x 1-9/16
cabinet moulding

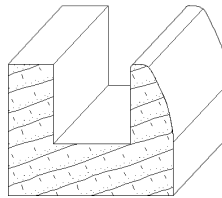

IH-251
1-1/4 x 1-9/16
cabinet moulding

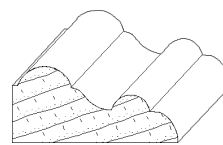

IH-207
3/4 x 1-5/8
cabinet moulding

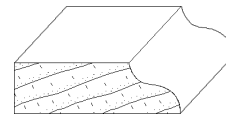

IH-273
1/2 x 1-5/8
cabinet moulding



INTEGRITY
ARCHITECTURAL
MILLWORK, INC.

Quality Architectural
Wood Products

2503 Taylor Street
Omaha, NE 68111

(402) 451-4110

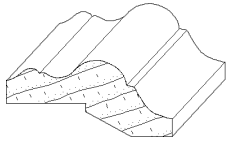

IH-280
3/4 x 1-5/8
cabinet moulding

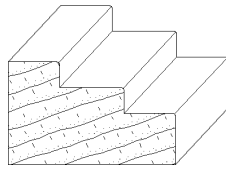

IH-287
1 x 1-5/8
cabinet moulding

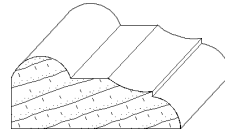

IH-201
3/4 x 1-3/4
cabinet moulding

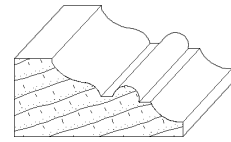

IH-203
13/16 x 1-3/4
cabinet moulding

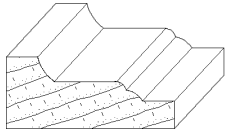

IH-211
3/4 x 1-3/4
cabinet moulding

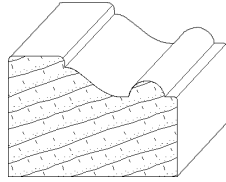

IH-212
1-1/4 x 1-3/4
cabinet moulding

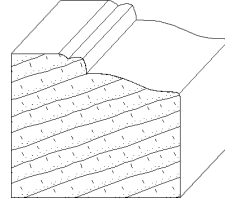

IH-222
1-1/2 x 1-3/4
cabinet moulding

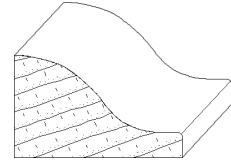

IH-229
1-1/16 x 1-3/4
cabinet moulding

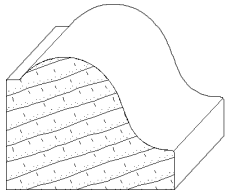

IH-232
1-3/8 x 1-3/4
cabinet moulding

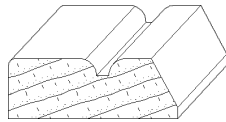

IH-235
5/8 x 1-3/4
cabinet moulding

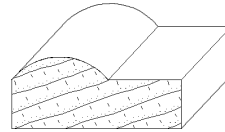

IH-242
3/4 x 1-3/4
cabinet moulding

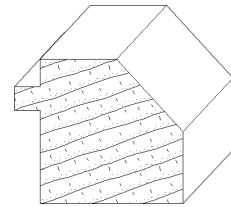

IH-245
1-1/2 x 1-3/4
cabinet moulding

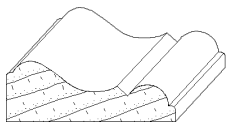

IH-246
5/8 x 1-3/4
cabinet moulding

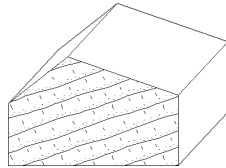

IH-250
1-1/8 x 1-3/4
cabinet moulding



IH-255
3/8 x 1-3/4
cabinet moulding

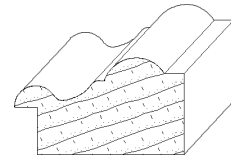

IH-259
1 x 1-3/4
cabinet moulding

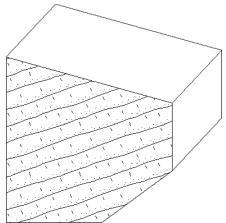

IH-268
1-3/4 x 1-3/4
cabinet moulding

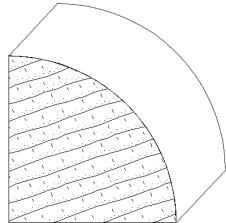

IH-276
1-3/4 x 1-3/4
cabinet moulding

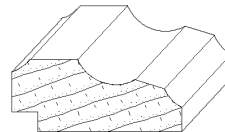

IH-285
3/4 x 1-3/4
cabinet moulding

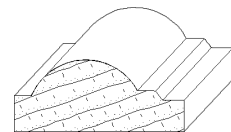

IH-1213
3/4 x 1-3/4
cabinet moulding

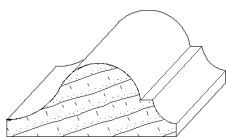

IH-1229
3/4 x 1-3/4
cabinet moulding

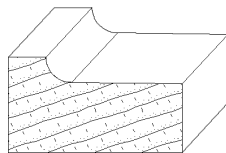

IH-241
1-1/16 x 1-15/16
cabinet moulding

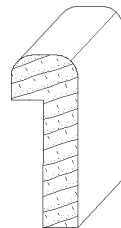

IH-291
3/4 x 1-15/16
cabinet moulding



INTEGRITY
ARCHITECTURAL
MILLWORK, INC.

Quality Architectural
Wood Products

2503 Taylor Street
Omaha, NE 68111

(402) 451-4110

2" Cabinet Moulding

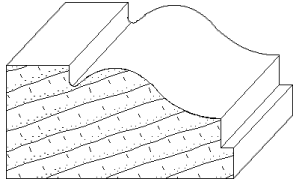

IH-210
1 x 2
cabinet moulding

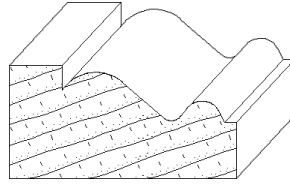

IH-216
1 x 2
cabinet moulding

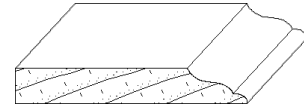

IH-234
5/16 x 2
cabinet moulding

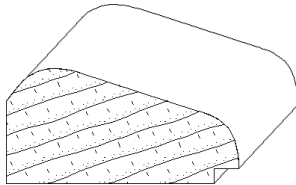

IH-236
1 x 2
cabinet moulding

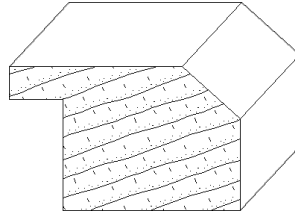

IH-256
1-1/4 x 2
cabinet moulding

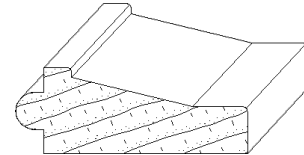

IH-258
3/4 x 2
cabinet moulding

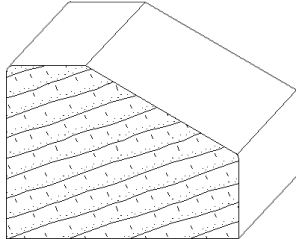

IH-264
1-1/2 x 2
cabinet moulding

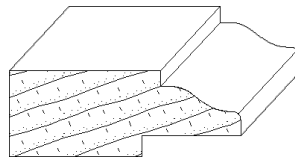

IH-272
3/4 x 2
cabinet moulding

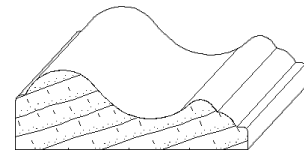

IH-281
11/16 x 2
cabinet moulding

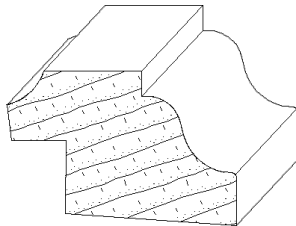

IH-1216
1-1/4 x 2
cabinet moulding

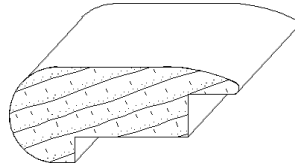

IH-1224
13/16 x 2
cabinet moulding

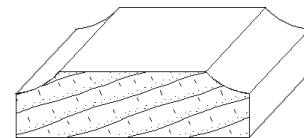

IH-1235
9/16 x 2
cabinet moulding

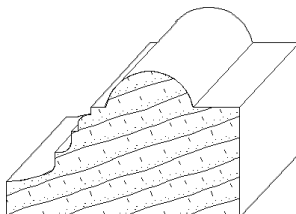

IH-1236
1-1/4 x 2
cabinet moulding

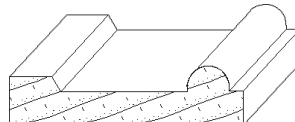

IH-292
1/2 x 2-1/16
cabinet moulding

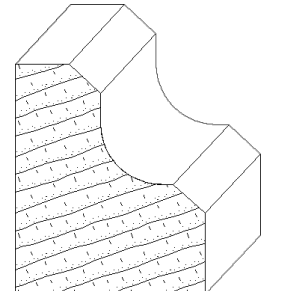

IH-1227
1-3/4 x 2-1/16
cabinet moulding



INTEGRITY
ARCHITECTURAL
MILLWORK, INC.

Quality Architectural
Wood Products

2503 Taylor Street
Omaha, NE 68111

(402) 451-4110

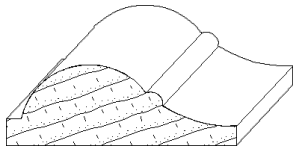

IH-215
3/4 x 2-1/8
cabinet moulding

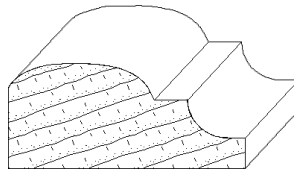

IH-225
1 x 2-1/4
cabinet moulding

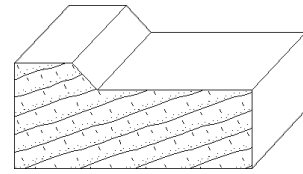

IH-227
1 x 2-1/4
cabinet moulding

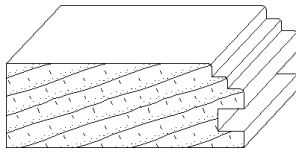

IH-244
13/16 x 2-1/4
cabinet moulding

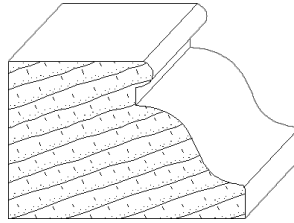

IH-248
1-1/2 x 2-1/4
cabinet moulding

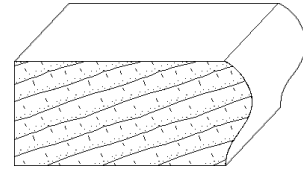

IH-254
1 x 2-1/4
cabinet moulding

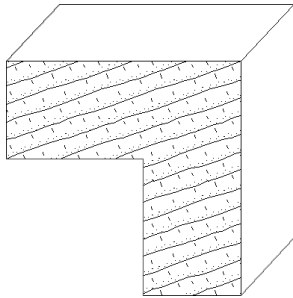

IH-274
2-1/4 x 2-1/4
cabinet moulding

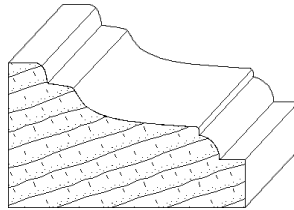

IH-275
1-3/8 x 2-1/4
cabinet moulding

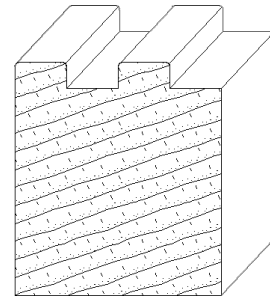

IH-1221
2 x 2-1/4
cabinet moulding



IH-1231
7/8 x 2-1/4
cabinet moulding

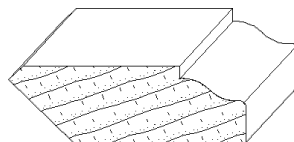

IH-271
3/4 x 2-5/16
cabinet moulding

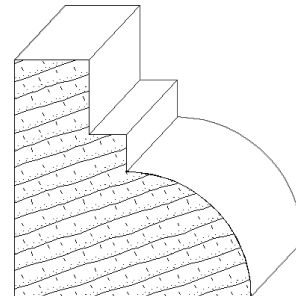

IH-1203
2-3/8 x 2-3/8
cabinet moulding



IH-224-A
3/4 x 2-3/8
cabinet moulding

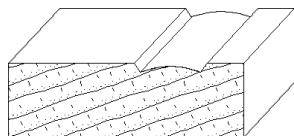

IH-224-B
3/4 x 2-3/8
cabinet moulding

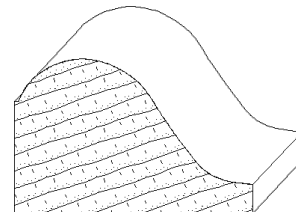

IH-223
1-5/8 x 2-1/2
cabinet moulding



INTEGRITY
ARCHITECTURAL
MILLWORK, INC.

Quality Architectural
Wood Products

2503 Taylor Street
Omaha, NE 68111

(402) 451-4110

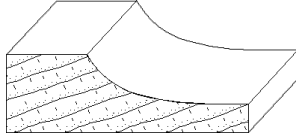

IH-240
13/16 x 2-1/2
cabinet moulding

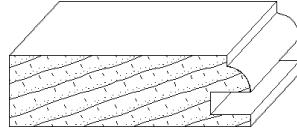

IH-270
3/4 x 2-1/2
cabinet moulding

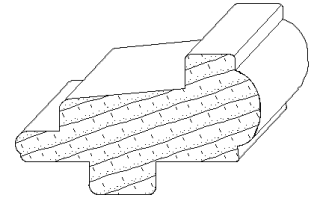

IH-1237
1-1/2 x 2-5/8
cabinet moulding

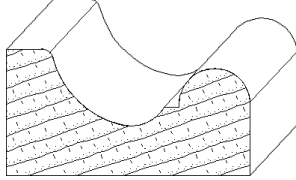

IH-1222
1-3/8 x 2-11/16
cabinet moulding

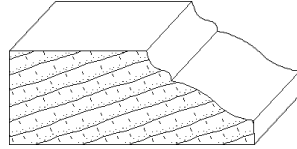

IH-238
1-1/16 x 2-3/4
cabinet moulding

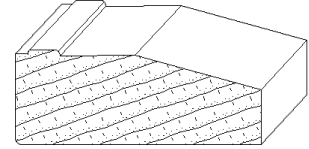

IH-239
1-1/16 x 2-3/4
cabinet moulding

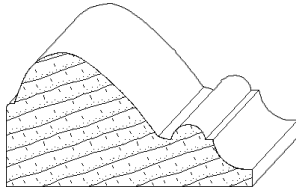

IH-243
1-1/2 x 2-3/4
cabinet moulding



INTEGRITY
ARCHITECTURAL
MILLWORK, INC.

Quality Architectural
Wood Products

2503 Taylor Street
Omaha, NE 68111

(402) 451-4110

3"+ Cabinet Moulding

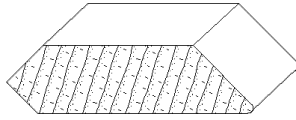

IH-1212
13/16 x 3-1/16
cabinet moulding

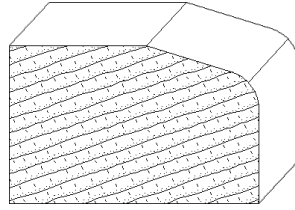

IH-249
2 x 3-3/16
cabinet moulding

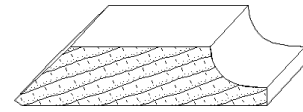

IH-1209
7/8 x 3-3/8
cabinet moulding

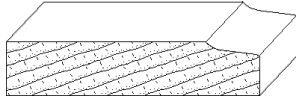

IH-279
3/4 x 3-1/2
cabinet moulding

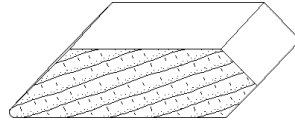

IH-1204
7/8 x 3-7/8
cabinet moulding

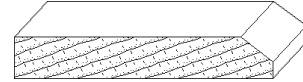

IH-282
5/8 x 4
cabinet moulding

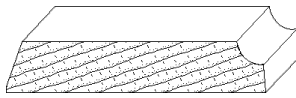

IH-1210
7/8 x 4-1/16
cabinet moulding

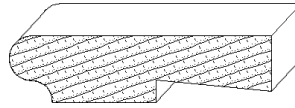

IH-1238
1-1/8 x 4-1/2
cabinet moulding

Cabinet Moulding in the Size, Profile and Species You Need

To discuss your project needs, please call us at (402) 451-4110 or [contact us online](#).

Product images are generally to scale but are not shown at actual size.



INTEGRITY
ARCHITECTURAL
MILLWORK, INC.

Quality Architectural
Wood Products

2503 Taylor Street
Omaha, NE 68111

(402) 451-4110



Casing Mouldings

Integrity Architectural Millwork has hundreds of casing profiles in our library. We keep Maple, Birch, Cherry, Red Oak and Poplar on hand and hundreds, if not thousands, of other species can also be ordered. We can also prepare window trim and door frames to your specifications. [Learn more](#)

Sizes: [Under 1 inch](#) | [1 inch](#) | [2 inch](#) | [3 inch](#) | [4 inch](#) | [5+ inch](#)

Under 1" Casings

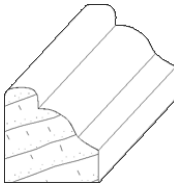

IH-462
5/8 x 5/8
casing moulding

1" Casings

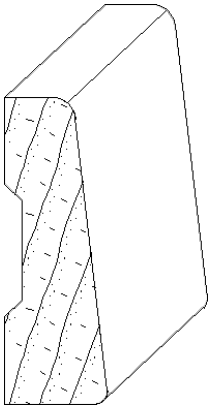

IH-1452
9/16 x 1-11/16
casing moulding

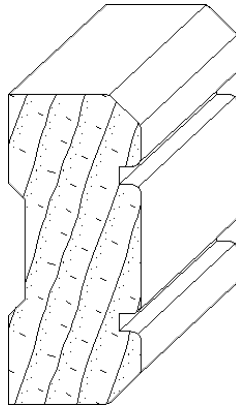

IH-1406
3/4 x 1-3/4
casing moulding

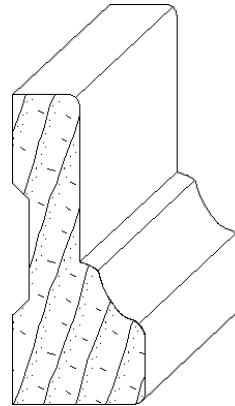

IH-1411
3/4 x 1-3/4
casing moulding

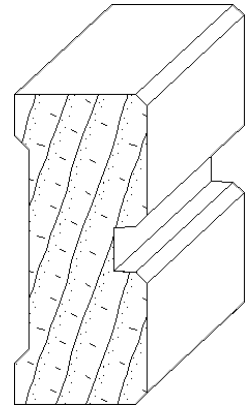

IH-1476
3/4 x 1-3/4
casing moulding



INTEGRITY
ARCHITECTURAL
MILLWORK, INC.

Quality Architectural
Wood Products

2503 Taylor Street
Omaha, NE 68111

(402) 451-4110

2" Casings

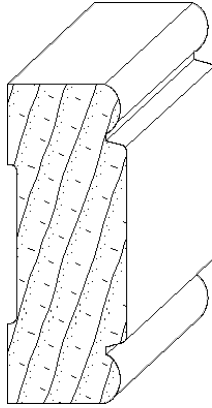

IH-405
3/4 x 2
casing moulding

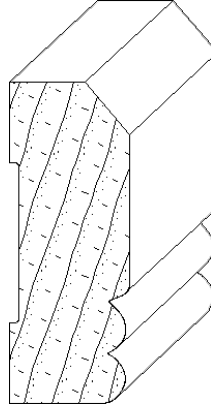

IH-423
3/4 x 2
casing moulding



IH-475
9/16 x 2
casing moulding

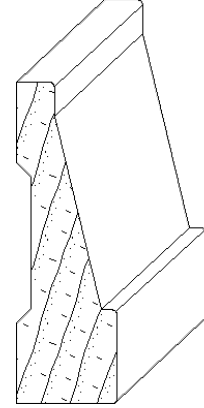

IH-496
5/8 x 2
casing moulding

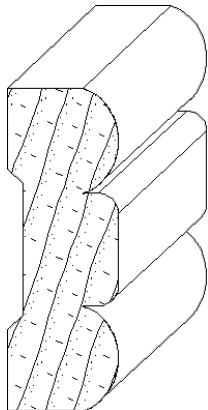

IH-1415
11/16 x 2
casing moulding

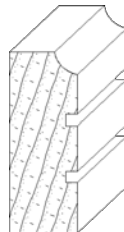

IH-1465
3/4 x 2
casing moulding

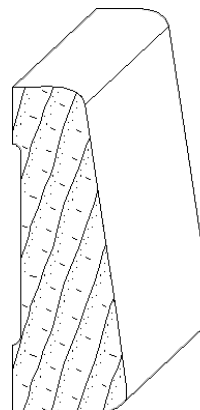

IH-446
3/4 x 2-1/8
casing moulding

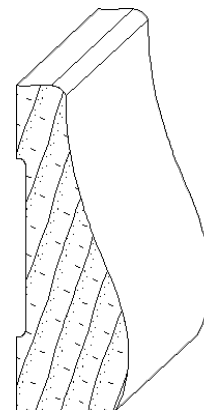

IH-452
3/4 x 2-3/16
casing moulding

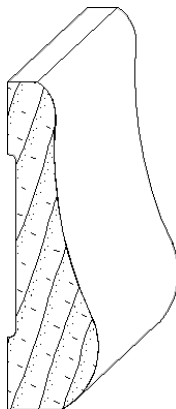

IH-453
5/8 x 2-3/16
casing moulding

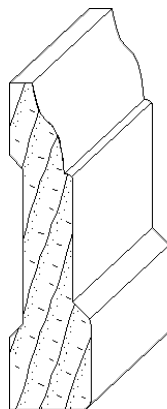

IH-401
9/16 x 2-1/4
casing moulding

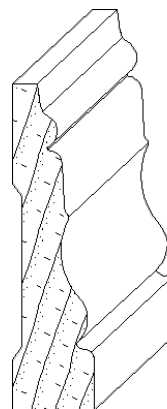

IH-402
9/16 x 2-1/4
casing moulding

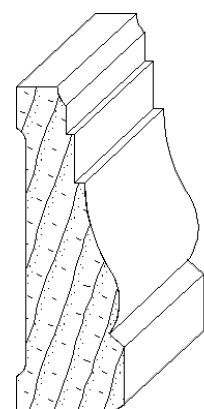

IH-420
3/4 x 2-1/4
casing moulding



INTEGRITY
ARCHITECTURAL
MILLWORK, INC.

Quality Architectural
Wood Products

2503 Taylor Street
Omaha, NE 68111

(402) 451-4110

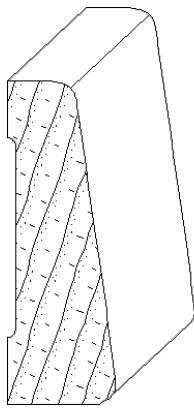

IH-421
3/4 x 2-1/4
casing moulding

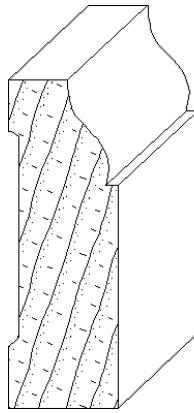

IH-422
3/4 x 2-1/4
casing moulding

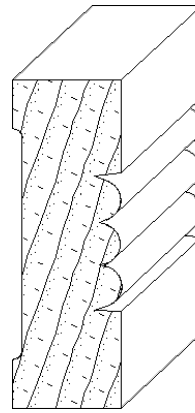

IH-424
3/4 x 2-1/4
casing moulding

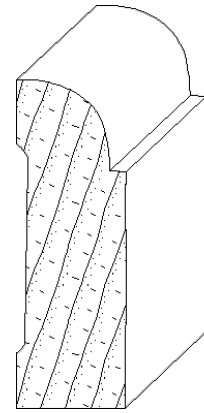

IH-425
3/4 x 2-1/4
casing moulding

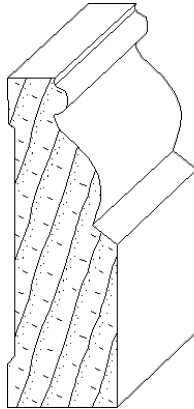

IH-440
3/4 x 2-1/4
casing moulding

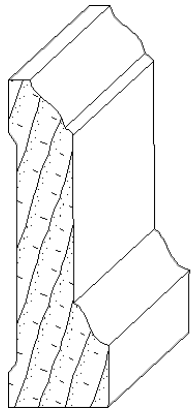

IH-443
11/16 x 2-1/4
casing moulding

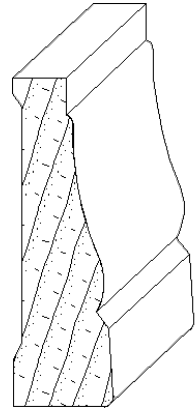

IH-444
11/16 x 2-1/4
casing moulding

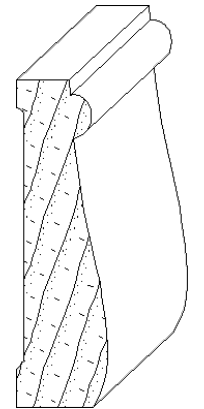

IH-455
5/8 x 2-1/4
casing moulding

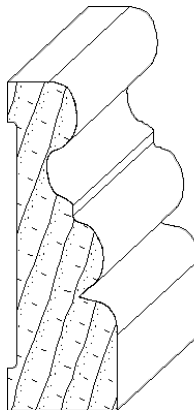

IH-470
3/4 x 2-1/4
casing moulding

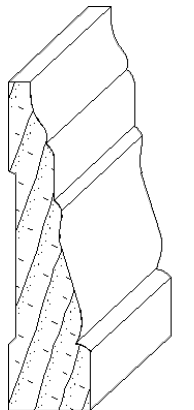

IH-473
9/16 x 2-1/4
casing moulding

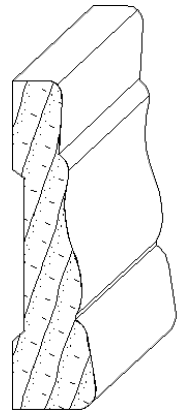

IH-498
1/2 x 2-1/4
casing moulding

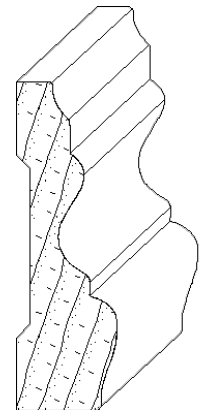

IH-1414
1/2 x 2-1/4
casing moulding



INTEGRITY
ARCHITECTURAL
MILLWORK, INC.

Quality Architectural
Wood Products

2503 Taylor Street
Omaha, NE 68111

(402) 451-4110

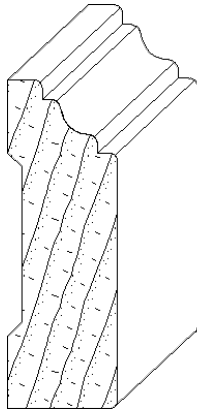

IH-1416
3/4 x 2-1/4
casing moulding

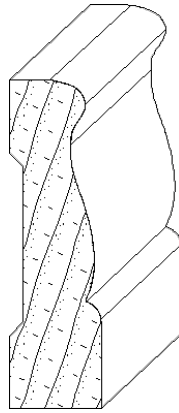

IH-1418
5/8 x 2-1/4
casing moulding

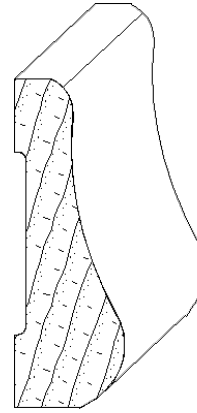

IH-1424
3/4 x 2-1/4
casing moulding

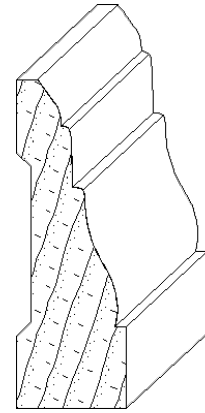

IH-1432
3/4 x 2-1/4
casing moulding

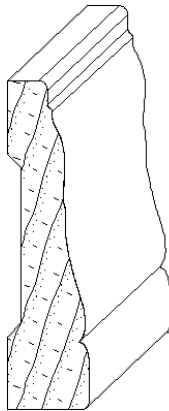

IH-1438
9/16 x 2-1/4
casing moulding

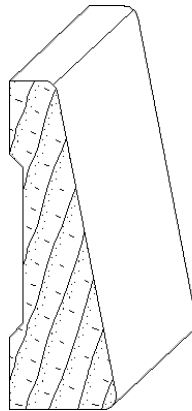

IH-1451
3/4 x 2-1/4
casing moulding

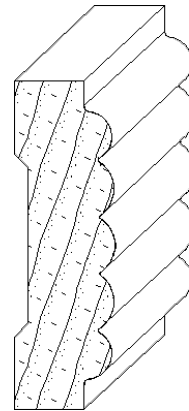

IH-1462
11/16 x 2-1/4
casing moulding

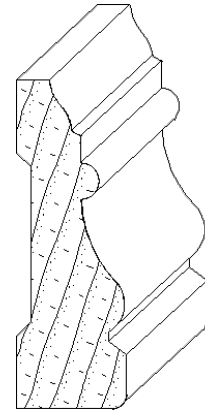

IH-1477
3/4 x 2-1/4
casing moulding

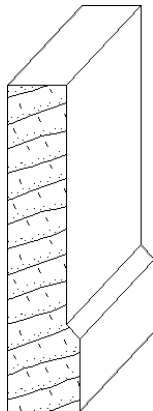

IH-14002
1/2 x 2-1/4
casing moulding

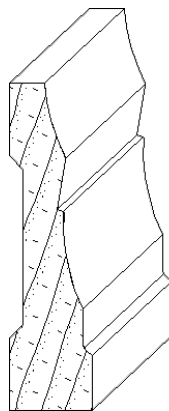

IH-4003 (MC2)
9/16 x 2-1/4
casing moulding

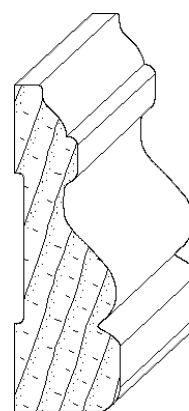

IH-416
3/4 x 2-5/16
casing moulding

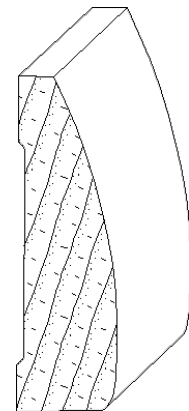

IH-426
3/4 x 2-1/2
casing moulding



INTEGRITY
ARCHITECTURAL
MILLWORK, INC.

Quality Architectural
Wood Products

2503 Taylor Street
Omaha, NE 68111

(402) 451-4110

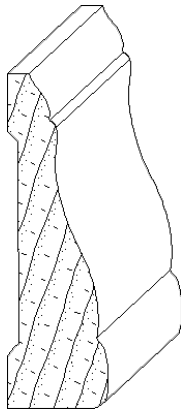

IH-460
3/4 x 2-1/2
casing moulding

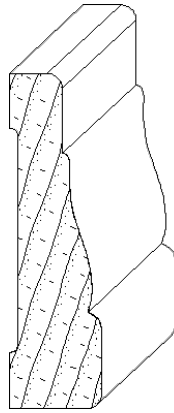

IH-461
11/16 x 2-1/2
casing moulding

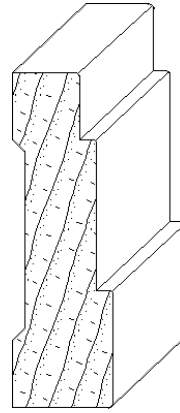

IH-484
3/4 x 2-1/2
casing moulding

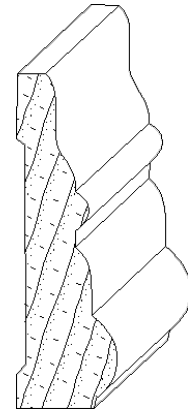

IH-487
3/4 x 2-1/2
casing moulding

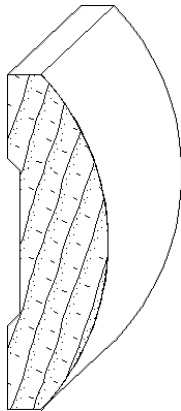

IH-490
3/4 x 2-1/2
casing moulding

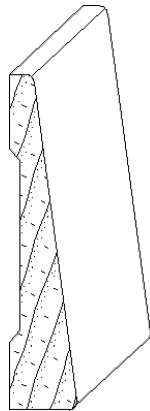

IH-1422
1/2 x 2-1/2
casing moulding

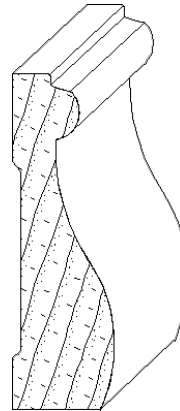

IH-1461
3/4 x 2-1/2
casing moulding

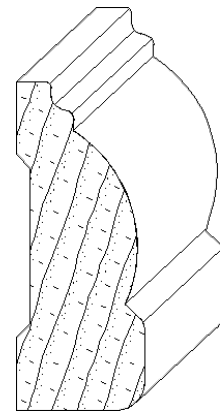

IH-1479
7/8 x 2-1/2
casing moulding

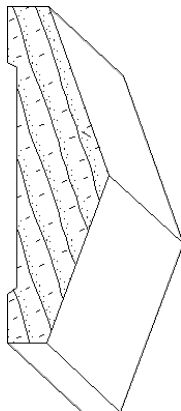

IH-1494
3/4 x 2-1/2
casing moulding

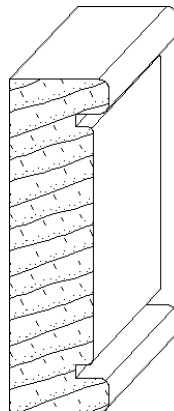

IH-14001
3/4 x 2-1/2
casing moulding

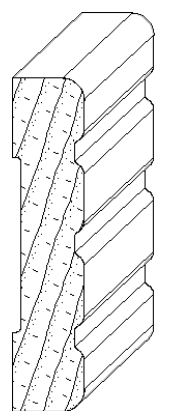

IH-414
9/16 x 2-5/8
casing moulding

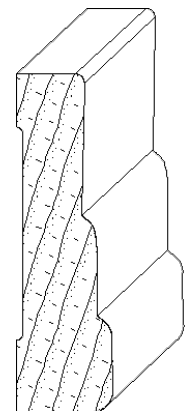

IH-451
3/4 x 2-5/8
casing moulding



INTEGRITY
ARCHITECTURAL
MILLWORK, INC.

Quality Architectural
Wood Products

2503 Taylor Street
Omaha, NE 68111

(402) 451-4110

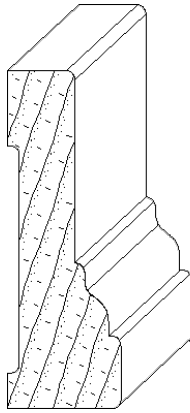

IH-468
7/8 x 2-5/8
casing moulding

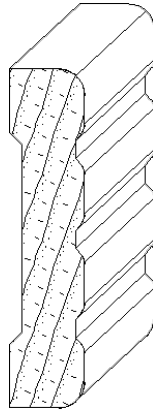

IH-1436
5/8 x 2-5/8
casing moulding

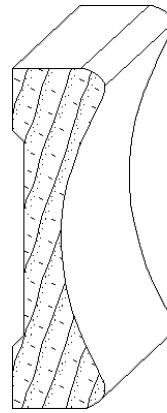

IH-433
3/4 x 2-3/4
casing moulding

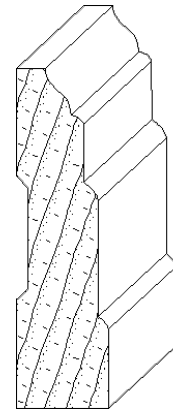

IH-437
3/4 x 2-3/4
casing moulding

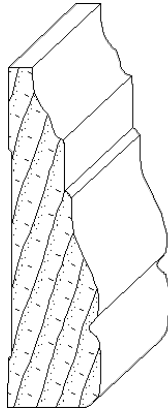

IH-469
3/4 x 2-3/4
casing moulding

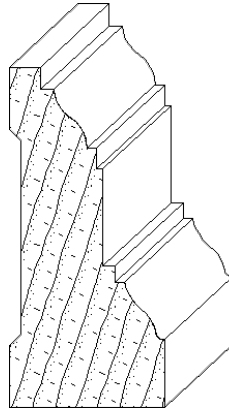

IH-1431
1-1/4 x 2-3/4
casing moulding

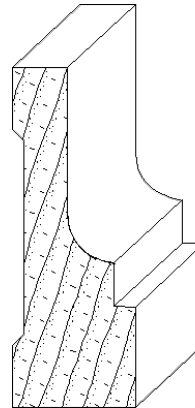

IH-1488
1 x 2-3/4
casing moulding

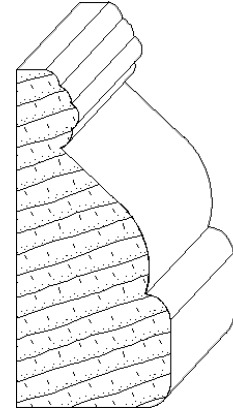

IH-14003
1-1/4 x 2-3/4
casing moulding

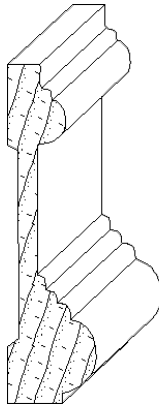

IH-413
3/4 x 2-7/8
casing moulding



INTEGRITY
ARCHITECTURAL
MILLWORK, INC.

Quality Architectural
Wood Products

2503 Taylor Street
Omaha, NE 68111

(402) 451-4110

3" Casings

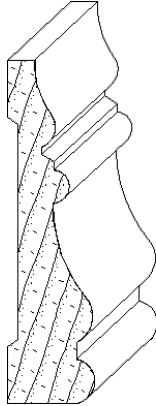

IH-406
3/4 x 3
casing moulding

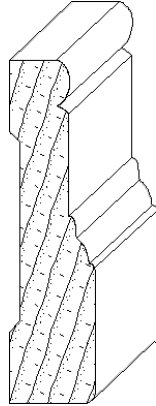

IH-407
3/4 x 3
casing moulding

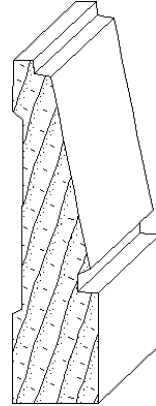

IH-409
11/16 x 3
casing moulding

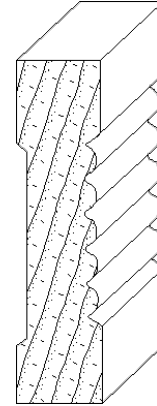

IH-412
3/4 x 3
casing moulding

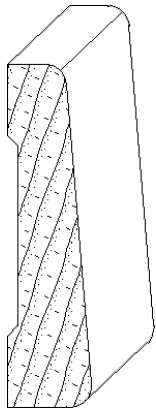

IH-415
3/4 x 3
casing moulding

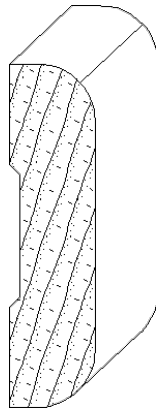

IH-419
3/4 x 3
casing moulding

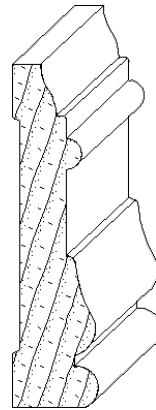

IH-430
3/4 x 3
casing moulding

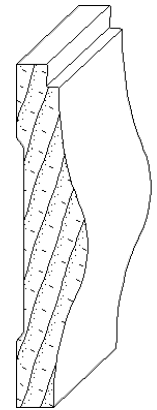

IH-432
5/8 x 3
casing moulding

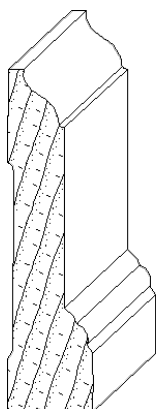

IH-435
3/4 x 3
casing moulding

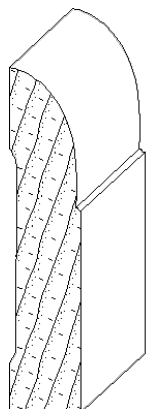

IH-445
5/8 x 3
casing moulding

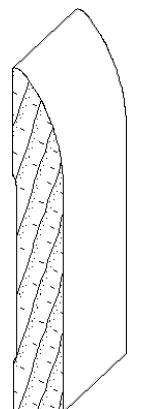

IH-454
7/16 x 3
casing moulding

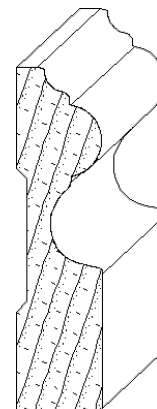

IH-463
3/4 x 3
casing moulding



INTEGRITY
ARCHITECTURAL
MILLWORK, INC.

Quality Architectural
Wood Products

2503 Taylor Street
Omaha, NE 68111

(402) 451-4110

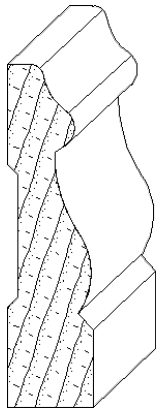

IH-471
3/4 x 3
casing moulding

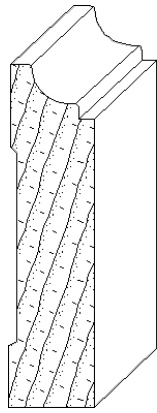

IH-474
3/4 x 3
casing moulding

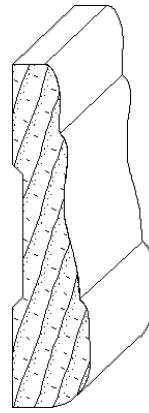

IH-478
11/16 x 3
casing moulding

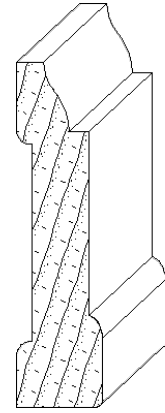

IH-488
3/4 x 3
casing moulding

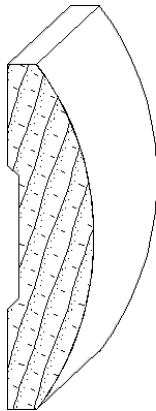

IH-492
3/4 x 3
casing moulding

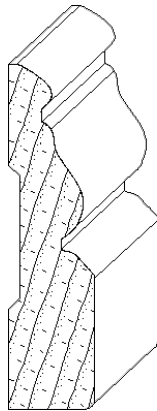

IH-493
3/4 x 3
casing moulding

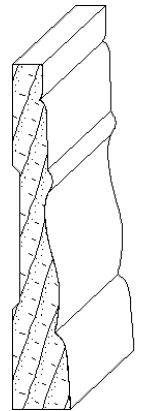

IH-1400
1/2 x 3
casing moulding

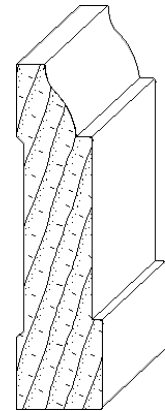

IH-1401
3/4 x 3
casing moulding

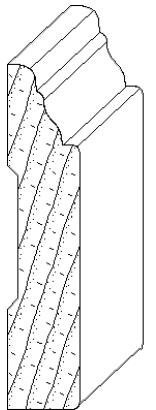

IH-1404
5/8 x 3
casing moulding

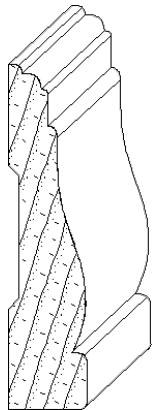

IH-1405
11/16 x 3
casing moulding

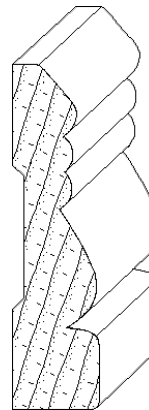

IH-1421
3/4 x 3
casing moulding

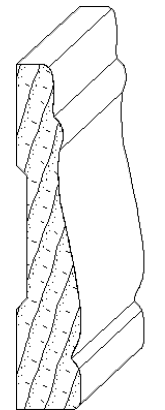

IH-1426
9/16 x 3
casing moulding



INTEGRITY
ARCHITECTURAL
MILLWORK, INC.

Quality Architectural
Wood Products

2503 Taylor Street
Omaha, NE 68111

(402) 451-4110

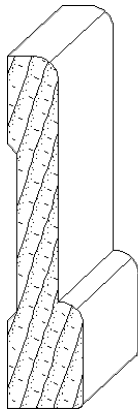

IH-1427
3/4 x 3
casing moulding

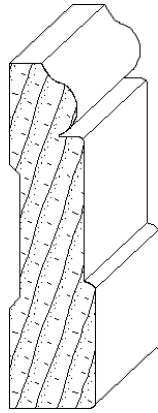

IH-1430
3/4 x 3
casing moulding

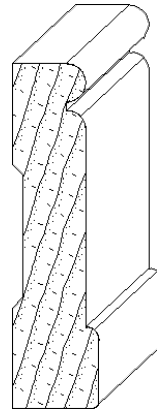

IH-1435
3/4 x 3
casing moulding

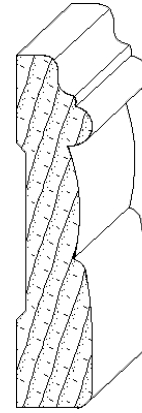

IH-1437
3/4 x 3
casing moulding

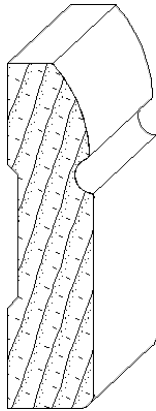

IH-1444
3/4 x 3
casing moulding

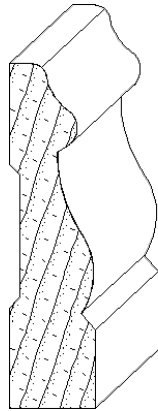

IH-1446
3/4 x 3
casing moulding

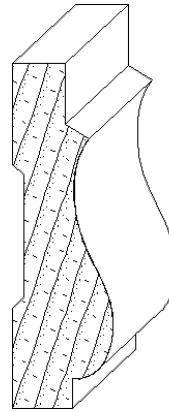

IH-1453
7/8 x 3
casing moulding

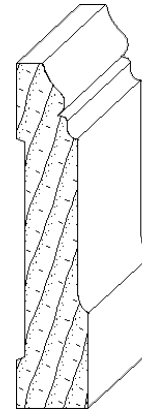

IH-1455
5/8 x 3
casing moulding

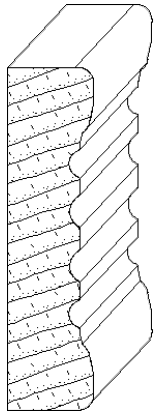

IH-1486
3/4 x 3
casing moulding

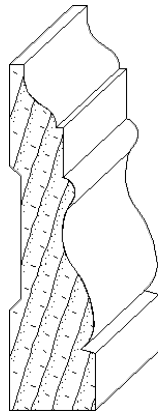

IH-1487
3/4 x 3
casing moulding

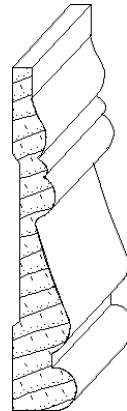

IH-1493
9/16 x 3
casing moulding

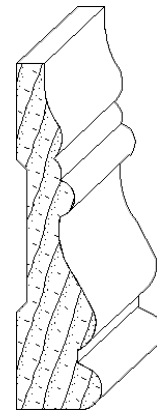

IH-4001 (MC1319)
3/4 x 3-1/8
casing moulding



INTEGRITY
ARCHITECTURAL
MILLWORK, INC.

Quality Architectural
Wood Products

2503 Taylor Street
Omaha, NE 68111

(402) 451-4110

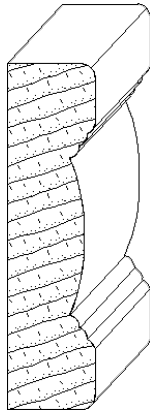

IH-14010
13/16 x 3-3/16
casing moulding

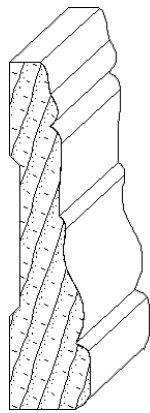

IH-417
3/4 x 3-1/4
casing moulding

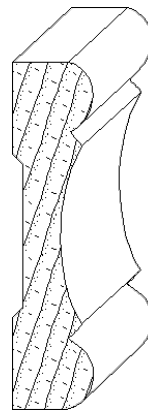

IH-428
3/4 x 3-1/4
casing moulding

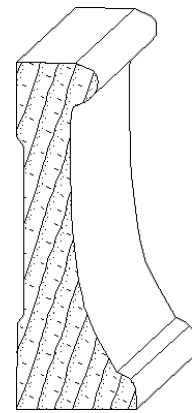

IH-431
1-1/16 x 3-1/4
casing moulding

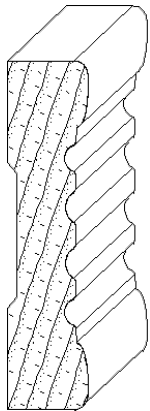

IH-438
3/4 x 3-1/4
casing moulding

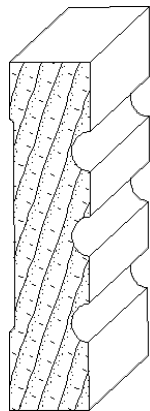

IH-439
3/4 x 3-1/4
casing moulding

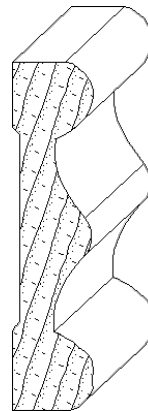

IH-458
3/4 x 3-1/4
casing moulding

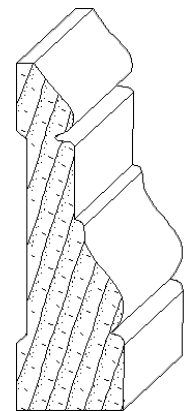

IH-466
1 x 3-1/4
casing moulding

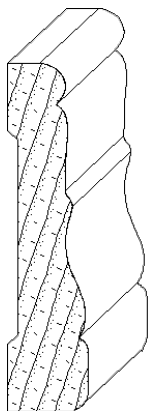

IH-479
3/4 x 3-1/4
casing moulding

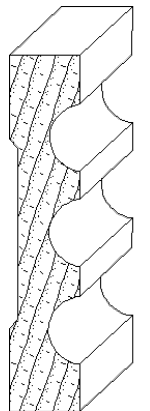

IH-486
3/4 x 3-1/4
casing moulding

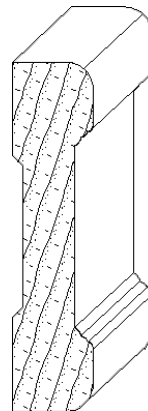

IH-494
3/4 x 3-1/4
casing moulding

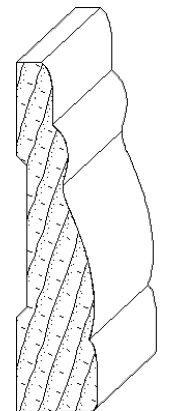

IH-1417
3/4 x 3-1/4
casing moulding



INTEGRITY
ARCHITECTURAL
MILLWORK, INC.

Quality Architectural
Wood Products

2503 Taylor Street
Omaha, NE 68111

(402) 451-4110

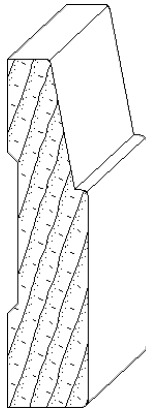

IH-1420
3/4 x 3-1/4
casing moulding

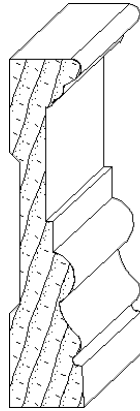

IH-1433
5/8 x 3-1/4
casing moulding

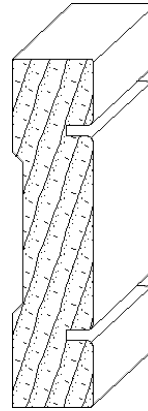

IH-1441
3/4 x 3-1/4
casing moulding

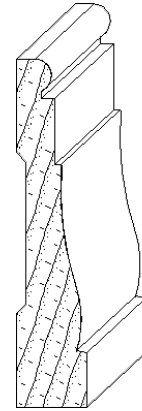

IH-1458
5/8 x 3-1/4
casing moulding

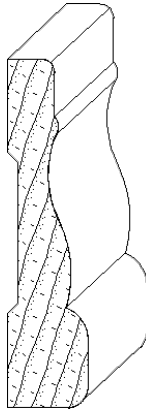

IH-1472
3/4 x 3-1/4
casing moulding

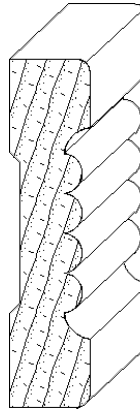

IH-1480
3/4 x 3-1/4
casing moulding

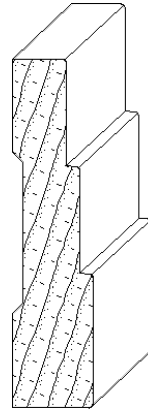

IH-1485
3/4 x 3-1/4
casing moulding

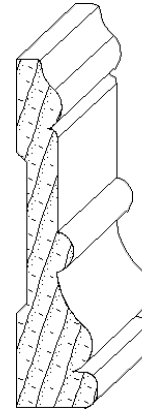

IH-1489
3/4 x 3-1/4
casing moulding

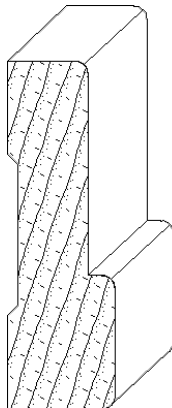

IH-1490
1 x 3-1/4
casing moulding

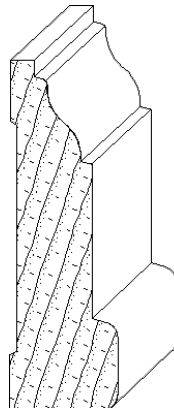

IH-1492
1 x 3-1/4
casing moulding

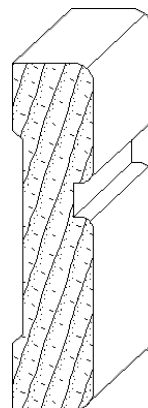

IH-1520-M
3/4 x 3-1/4
casing moulding

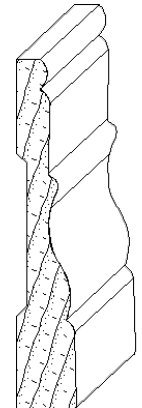

IH-4016 (178-A)
9/16 x 3-1/4
casing moulding



INTEGRITY
ARCHITECTURAL
MILLWORK, INC.

Quality Architectural
Wood Products

2503 Taylor Street
Omaha, NE 68111

(402) 451-4110

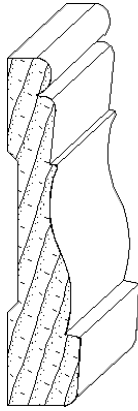

IH-4002 (MC131)
11/16 x 3-1/4
casing moulding

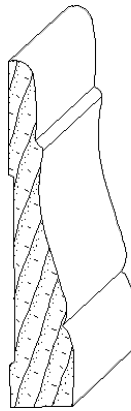

IH-404
3/4 x 3-5/16
casing moulding

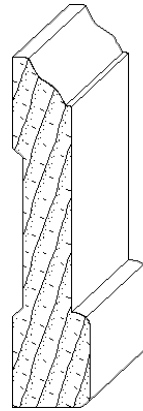

IH-1410
3/4 x 3-3/8
casing moulding

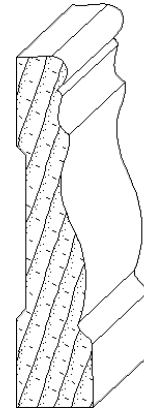

IH-459
3/4 x 3-7/16
casing moulding

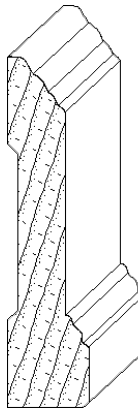

IH-410
13/16 x 3-1/2
casing moulding

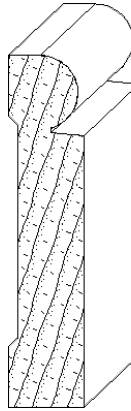

IH-448
3/4 x 3-1/2
casing moulding

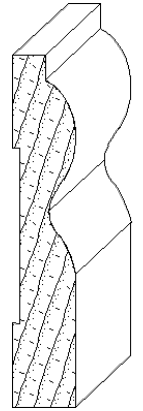

IH-456
5/8 x 3-1/2
casing moulding

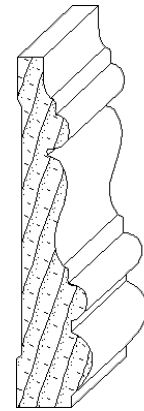

IH-465
3/4 x 3-1/2
casing moulding



IH-497
7/8 x 3-1/2
casing moulding

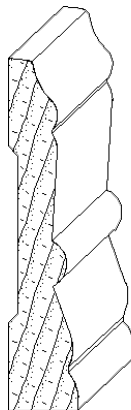

IH-1402
11/16 x 3-1/2
casing moulding

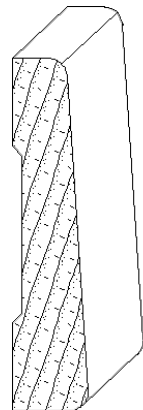

IH-1434
3/4 x 3-1/2
casing moulding

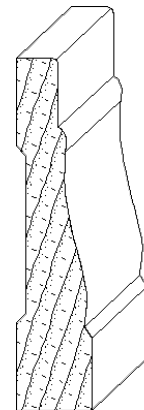

IH-1439
3/4 x 3-1/2
casing moulding



INTEGRITY
ARCHITECTURAL
MILLWORK, INC.

Quality Architectural
Wood Products

2503 Taylor Street
Omaha, NE 68111

(402) 451-4110

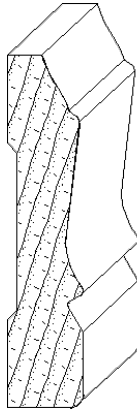

IH-1445
3/4 x 3-1/2
casing moulding

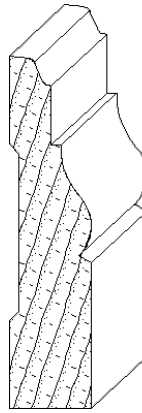

IH-1457
13/16 x 3-1/2
casing moulding

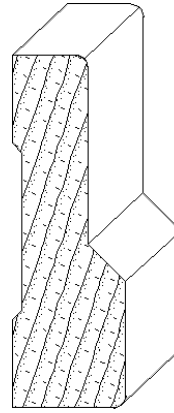

IH-1460
1-1/8 x 3-1/2
casing moulding



IH-1466
3/4 x 3-1/2
casing moulding

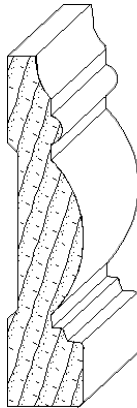

IH-1467
3/4 x 3-1/2
casing moulding

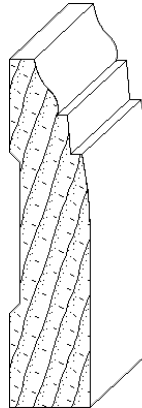

IH-1470
3/4 x 3-1/2
casing moulding

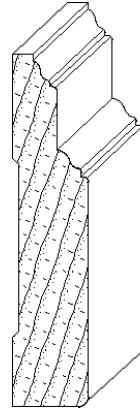

IH-1478
3/4 x 3-1/2
casing moulding

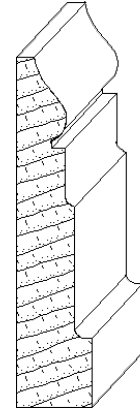

IH-1495
3/4 x 3-1/2
casing moulding

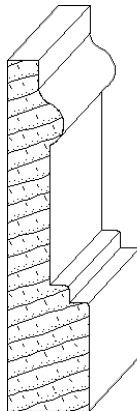

IH-4000
13/16 x 3-1/2
casing moulding

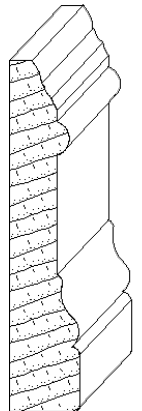

IH-4007
11/16 x 3-1/2
casing moulding

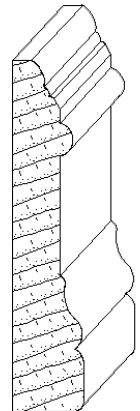

IH-14005
11/16 x 3-1/2
casing moulding

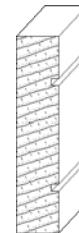

IH-14006
3/4 x 3-1/2
casing moulding



INTEGRITY
ARCHITECTURAL
MILLWORK, INC.

Quality Architectural
Wood Products

2503 Taylor Street
Omaha, NE 68111

(402) 451-4110

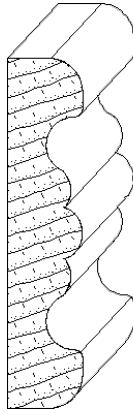

IH-14008
3/4 x 3-1/2
casing moulding

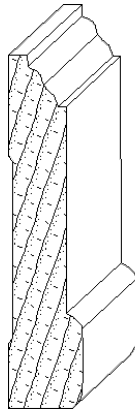

IH-450
3/4 x 3-9/16
casing moulding

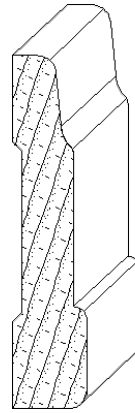

IH-495
3/4 x 3-9/16
casing moulding



IH-457
13/16 x 3-5/8
casing moulding

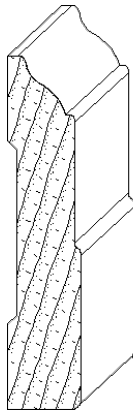

IH-489
3/4 x 3-5/8
casing moulding

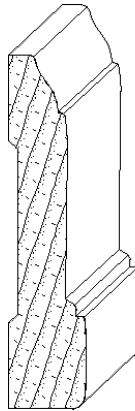

IH-1450
13/16 x 3-5/8
casing moulding

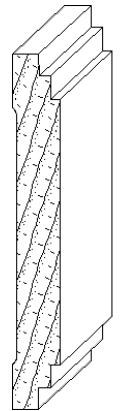

IH-436
1/2 x 3-3/4
casing moulding

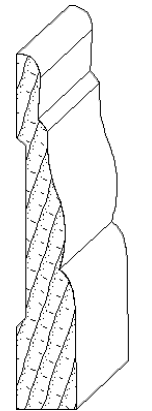

IH-1448
5/8 x 3-3/4
casing moulding

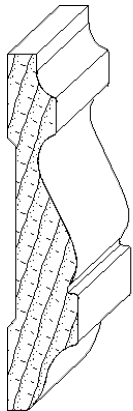

IH-1471
3/4 x 3-3/4
casing moulding

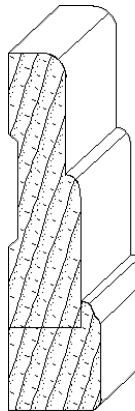

IH-1409
1 x 3-7/8
casing moulding



INTEGRITY
ARCHITECTURAL
MILLWORK, INC.

Quality Architectural
Wood Products

2503 Taylor Street
Omaha, NE 68111

(402) 451-4110

4" Casings

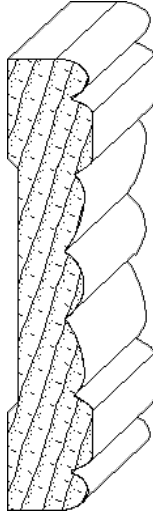

IH-411
3/4 x 4
casing moulding

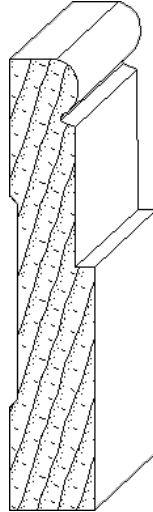

IH-429
3/4 x 4
casing moulding

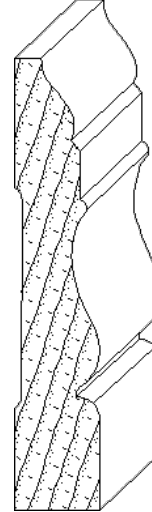

IH-464
3/4 x 4
casing moulding



IH-481
3/4 x 4
casing moulding

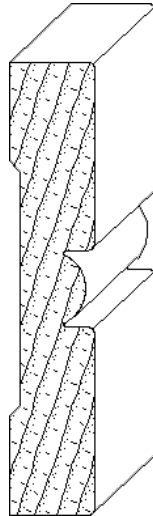

IH-1403
3/4 x 4
casing moulding

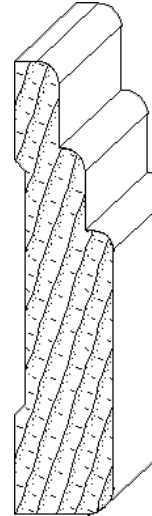

IH-1412
7/8 x 4
casing moulding



INTEGRITY
ARCHITECTURAL
MILLWORK, INC.

Quality Architectural
Wood Products

2503 Taylor Street
Omaha, NE 68111

(402) 451-4110

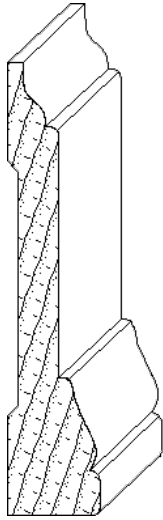

IH-1423
13/16 x 4
casing moulding

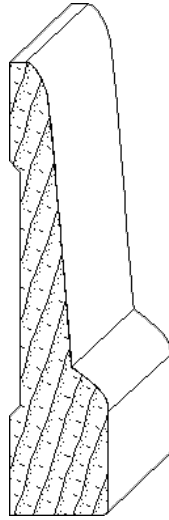

IH-1428
7/8 x 4
casing moulding

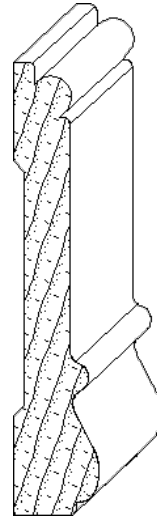

IH-1443
3/4 x 4
casing moulding

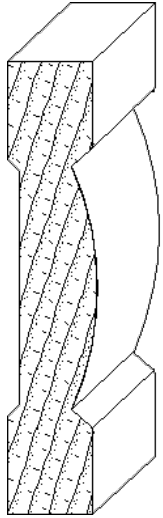

IH-1447
3/4 x 4
casing moulding

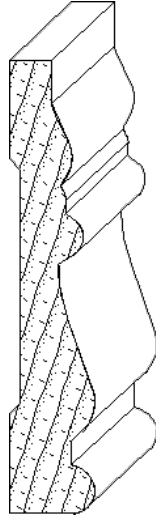

IH-1454
3/4 x 4
casing moulding

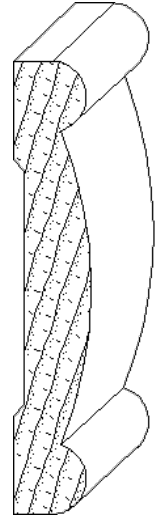

IH-1456
11/16 x 4
casing moulding



INTEGRITY
ARCHITECTURAL
MILLWORK, INC.

Quality Architectural
Wood Products

2503 Taylor Street
Omaha, NE 68111

(402) 451-4110

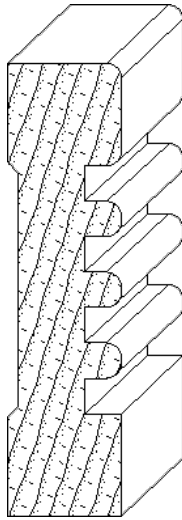

IH-1459
1 x 4
casing moulding

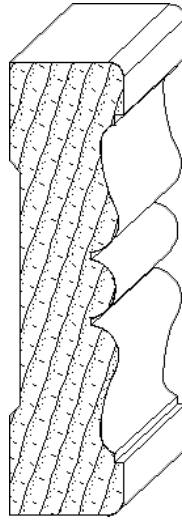

IH-1473
1 x 4
casing moulding

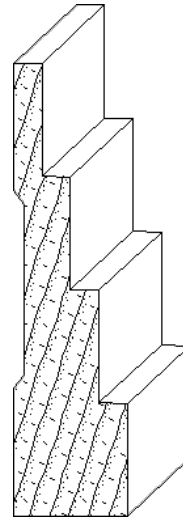

IH-1481
1 x 4
casing moulding

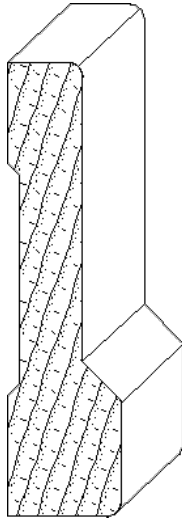

IH-1484
1 x 4
casing moulding

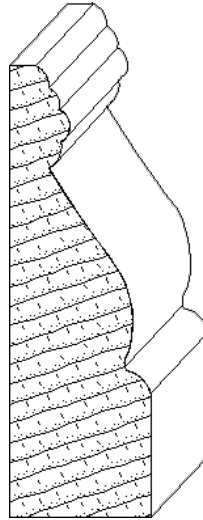

IH-1496
1-1/4 x 4
casing moulding

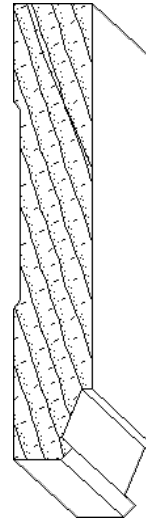

IH-1499
11/16 x 4
casing moulding



INTEGRITY
ARCHITECTURAL
MILLWORK, INC.

Quality Architectural
Wood Products

2503 Taylor Street
Omaha, NE 68111

(402) 451-4110

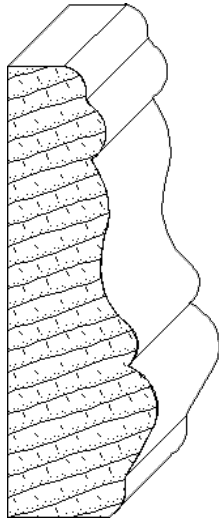

IH-14011
1-1/4 x 4
casing moulding

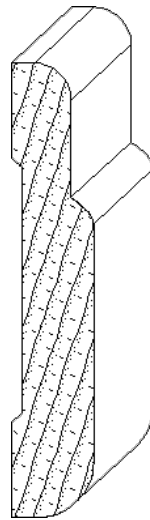

IH-1407
3/4 x 4-3/16
casing moulding

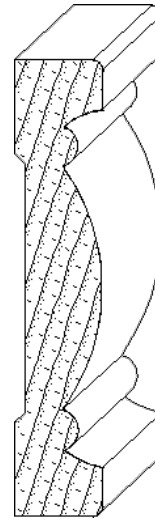

IH-1475
13/16 x 4-1/4
casing moulding

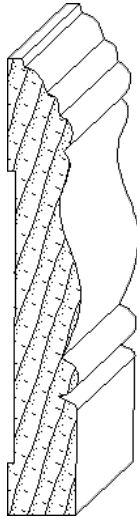

IH-472
11/16 x 4-5/16
casing moulding

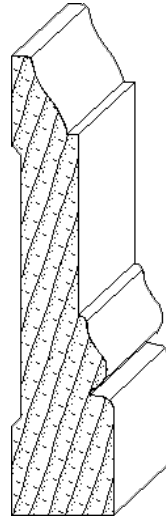

IH-447
1 x 4-1/2
casing moulding

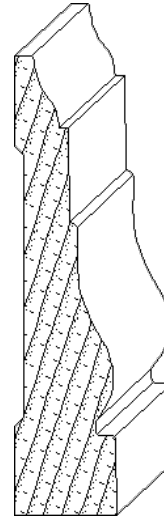

IH-467
1 x 4-1/2
casing moulding



INTEGRITY
ARCHITECTURAL
MILLWORK, INC.

Quality Architectural
Wood Products

2503 Taylor Street
Omaha, NE 68111

(402) 451-4110

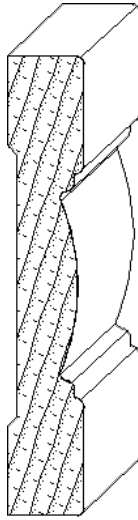

IH-1408
3/4 x 4-1/2
casing moulding

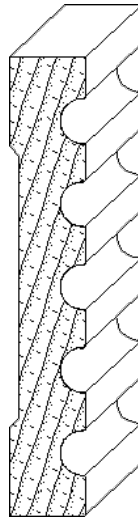

IH-1419
3/4 x 4-1/2
casing moulding

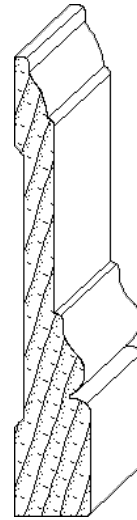

IH-1425
3/4 x 4-1/2
casing moulding

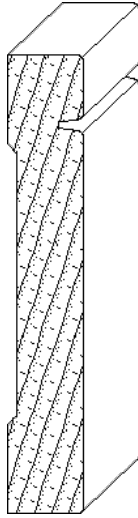

IH-1442
3/4 x 4-1/2
casing moulding

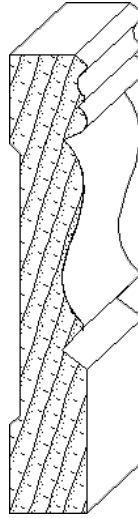

IH-1449
3/4 x 4-1/2
casing moulding

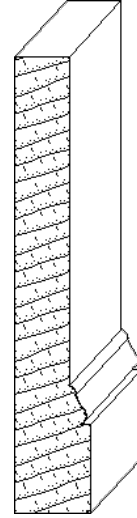

IH-1491
3/4 x 4-1/2
casing moulding



INTEGRITY
ARCHITECTURAL
MILLWORK, INC.

Quality Architectural
Wood Products

2503 Taylor Street
Omaha, NE 68111

(402) 451-4110

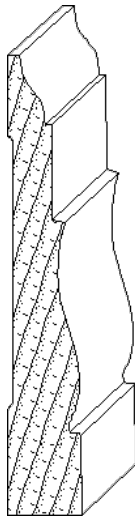

IH-408
3/4 x 4-9/16
casing moulding

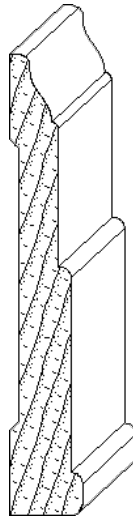

IH-434
3/4 x 4-5/8
casing moulding

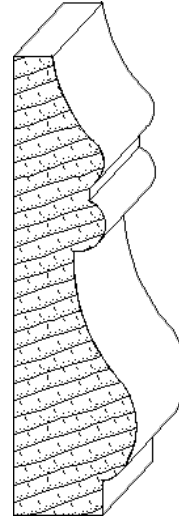

IH-14004
1-1/4 x 4-11/16
casing moulding

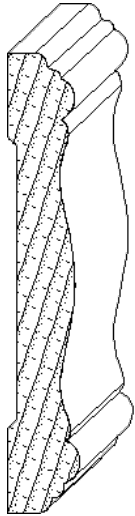

IH-403
3/4 x 4-3/4
casing moulding

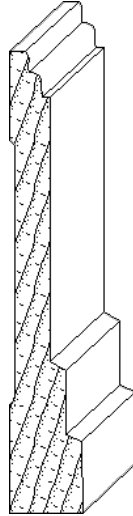

IH-441
3/4 x 4-3/4
casing moulding

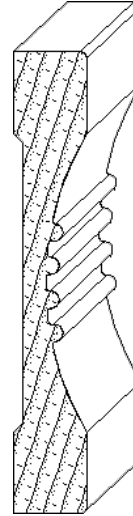

IH-477
3/4 x 4-3/4
casing moulding



INTEGRITY
ARCHITECTURAL
MILLWORK, INC.

Quality Architectural
Wood Products

2503 Taylor Street
Omaha, NE 68111

(402) 451-4110

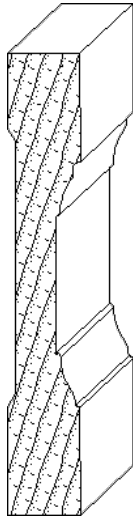

IH-480
3/4 x 4-3/4
casing moulding

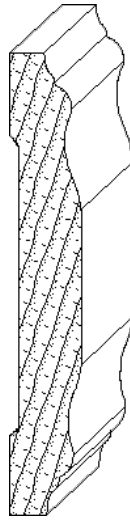

IH-427
3/4 x 4-7/8
casing moulding

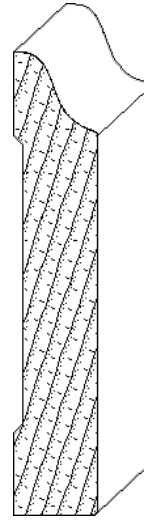

IH-1413
7/8 x 4-7/8
casing moulding

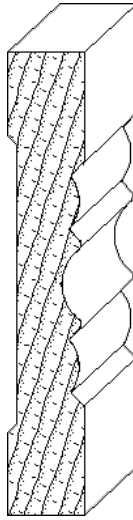

IH-1483
13/16 x 4-7/8
casing moulding



INTEGRITY
ARCHITECTURAL
MILLWORK, INC.

Quality Architectural
Wood Products

2503 Taylor Street
Omaha, NE 68111

(402) 451-4110

5+'' Casings

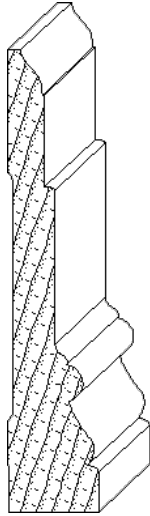

IH-442
1 x 5
casing moulding

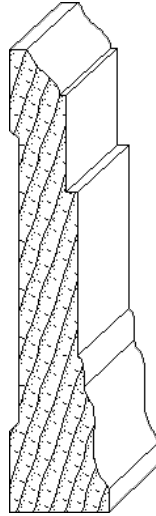

IH-449
1-1/16 x 5
casing moulding

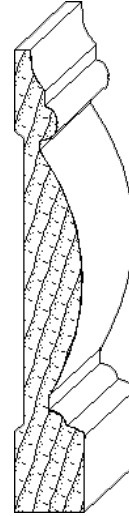

IH-1469
3/4 x 5
casing moulding

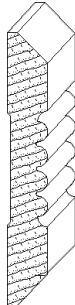

IH-4009
3/4 x 5
casing moulding

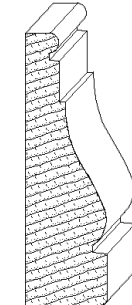

IH-4012
1-1/2 x 5
casing moulding

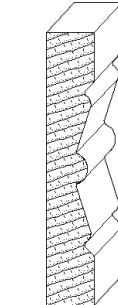

IH-14009
7/8 x 5
casing moulding



IH-491
11/16 x 5-1/8
casing moulding



IH-400
3/4 x 5-1/4
casing moulding

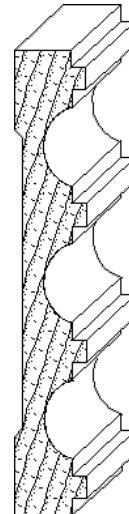

IH-1429
13/16 x 5-1/4
casing moulding



INTEGRITY
ARCHITECTURAL
MILLWORK, INC.

Quality Architectural
Wood Products

2503 Taylor Street
Omaha, NE 68111

(402) 451-4110

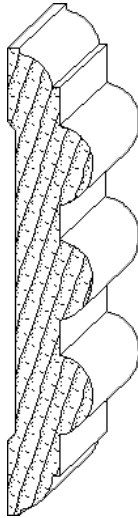

IH-499
1 x 5-1/2
casing moulding



IH-1474
3/4 x 5-1/2
casing moulding

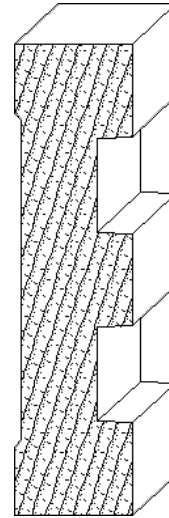

IH-1482
1-1/2 x 6
casing moulding

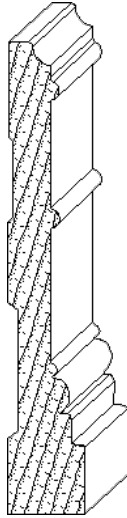

IH-476
1 x 6-1/8
casing moulding

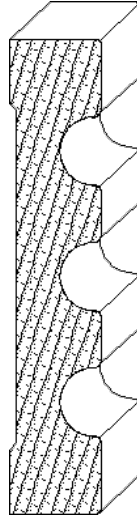

IH-482
1-1/4 x 6-1/2
casing moulding

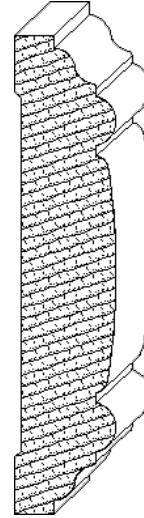

IH-485
1-9/16 x 7-3/8
casing moulding



INTEGRITY
ARCHITECTURAL
MILLWORK, INC.

Quality Architectural
Wood Products

2503 Taylor Street
Omaha, NE 68111

(402) 451-4110

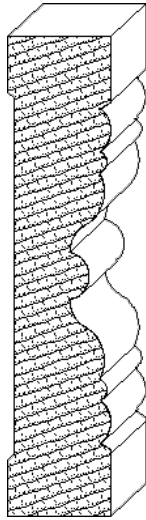

IH-483
1-5/8 x 7-1/2
casing moulding

Casing in the Size, Profile and Species You Need

To discuss your project needs, please call us at (402) 451-4110 or [contact us online.](#)

Product images are generally to scale but are not shown at actual size.



INTEGRITY
ARCHITECTURAL
MILLWORK, INC.

Quality Architectural
Wood Products

2503 Taylor Street
Omaha, NE 68111

(402) 451-4110



Chair Rail Mouldings

Integrity Architectural Millwork's Chair Rail is available in a variety of widths and, since all our millwork is prepared to your specifications, in the lengths you need. While we keep Maple, Birch, Cherry, Red Oak and Poplar on hand, hundreds, if not thousands, of other species can also be ordered.

Sizes: [1 inch](#) | [2 inch](#) | [3 inch](#) | [4 inch](#) | [5+ inch](#)

1" Chair Rail Moulding

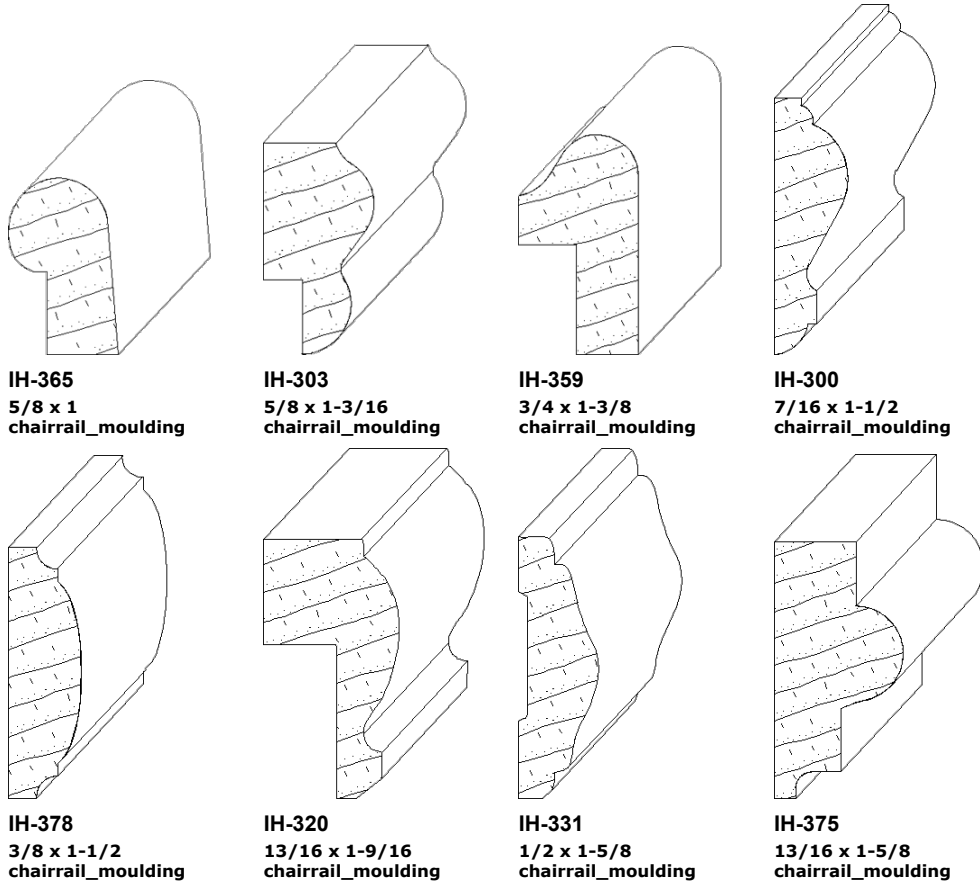



INTEGRITY
ARCHITECTURAL
MILLWORK, INC.

Quality Architectural
Wood Products

2503 Taylor Street
Omaha, NE 68111

(402) 451-4110

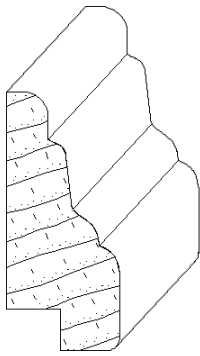

IH-362
3/4 x 1-11/16
chairrail_moulding

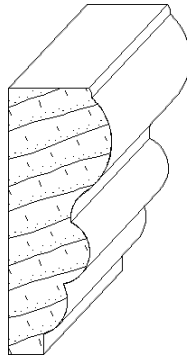

IH-313
11/16 x 1-3/4
chairrail_moulding

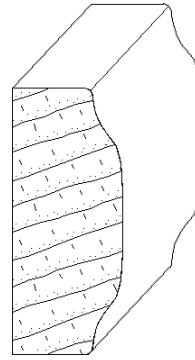

IH-328
3/4 x 1-3/4
chairrail_moulding

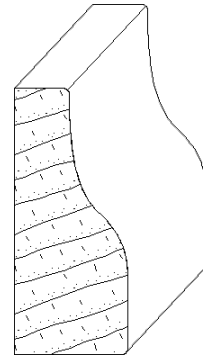

IH-339
3/4 x 1-3/4
chairrail_moulding

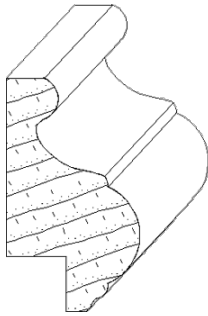

IH-358
1 x 1-3/4
chairrail_moulding

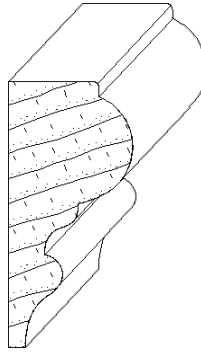

IH-363
7/8 x 1-7/8
chairrail_moulding

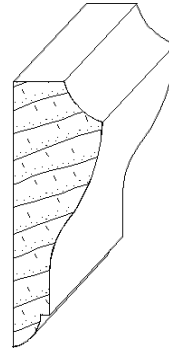

IH-383
5/8 x 1-7/8
chairrail_moulding

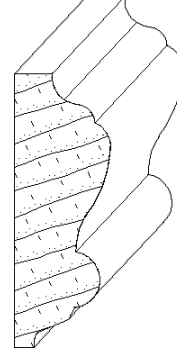

IH-318
11/16 x 1-15/16
chairrail_moulding



INTEGRITY
ARCHITECTURAL
MILLWORK, INC.

Quality Architectural
Wood Products

2503 Taylor Street
Omaha, NE 68111

(402) 451-4110

2" Chair Rail Moulding

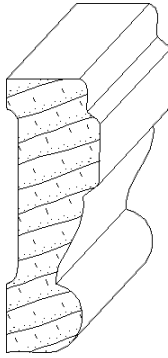

IH-307
11/16 x 2
chairrail_moulding

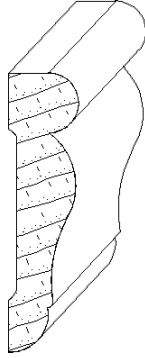

IH-316
7/16 x 2
chairrail_moulding

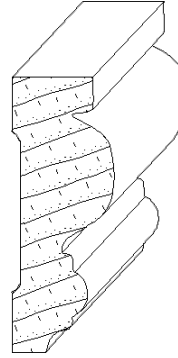

IH-349
3/4 x 2
chairrail_moulding

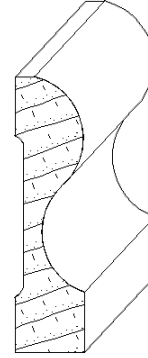

IH-368
1/2 x 2
chairrail_moulding

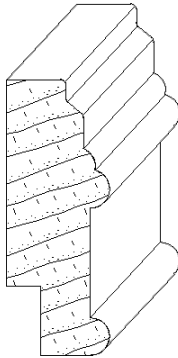

IH-377
3/4 x 2
chairrail_moulding

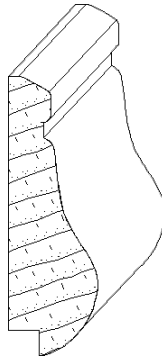

IH-360
11/16 x 2-1/8
chairrail_moulding

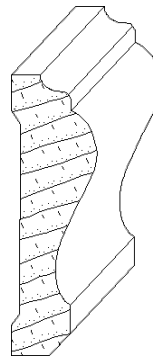

IH-309
11/16 x 2-1/4
chairrail_moulding

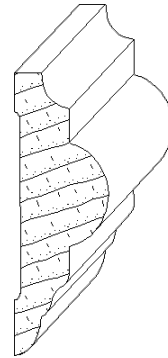

IH-310
3/4 x 2-1/4
chairrail_moulding

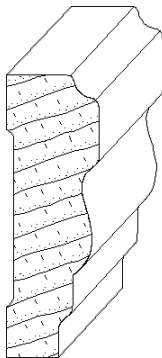

IH-311
3/4 x 2-1/4
chairrail_moulding

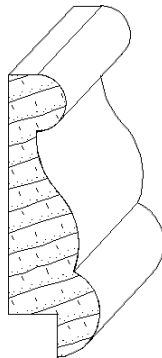

IH-315
3/4 x 2-1/4
chairrail_moulding

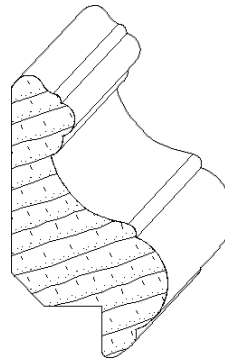

IH-357
1-1/4 x 2-1/4
chairrail_moulding

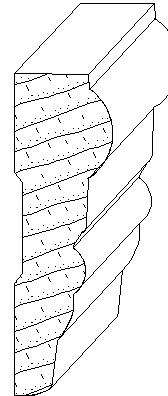

IH-369
3/4 x 2-1/4
chairrail_moulding



INTEGRITY
ARCHITECTURAL
MILLWORK, INC.

Quality Architectural
Wood Products

2503 Taylor Street
Omaha, NE 68111

(402) 451-4110

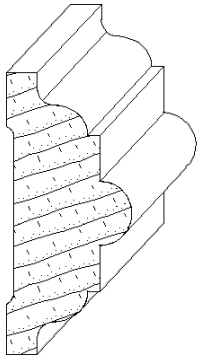

IH-376
1 x 2-1/4
chairrail_moulding

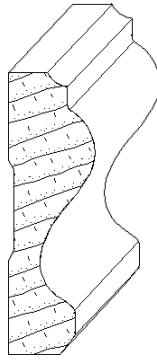

IH-388
11/16 x 2-1/4
chairrail_moulding

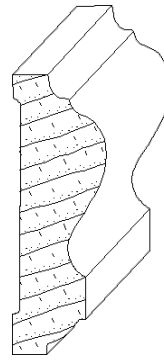

IH-306
3/4 x 2-5/16
chairrail_moulding

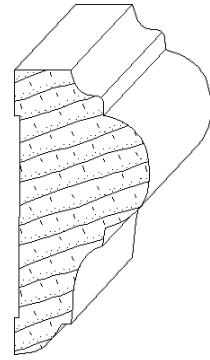

IH-329
1-1/8 x 2-3/8
chairrail_moulding

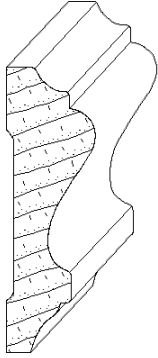

IH-381
3/4 x 2-3/8
chairrail_moulding

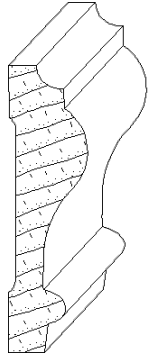

IH-305
5/8 x 2-1/2
chairrail_moulding

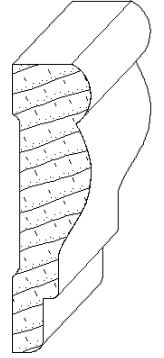

IH-332
11/16 x 2-1/2
chairrail_moulding

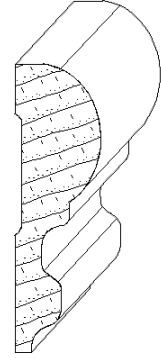

IH-345
3/4 x 2-1/2
chairrail_moulding

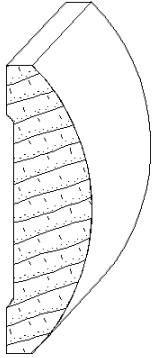

IH-348
3/4 x 2-1/2
chairrail_moulding

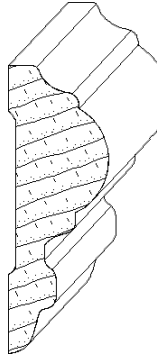

IH-353
7/8 x 2-1/2
chairrail_moulding

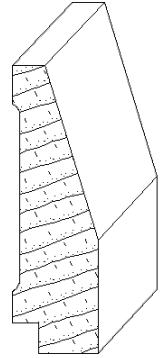

IH-366
3/4 x 2-1/2
chairrail_moulding

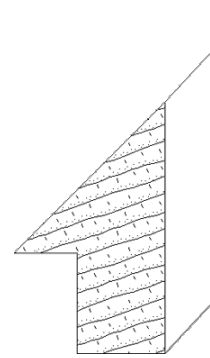

IH-374
1-1/2 x 2-1/2
chairrail_moulding



INTEGRITY
ARCHITECTURAL
MILLWORK, INC.

Quality Architectural
Wood Products

2503 Taylor Street
Omaha, NE 68111

(402) 451-4110

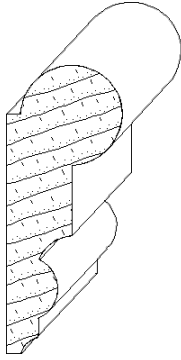

IH-385
1 x 2-1/2
chairrail_moulding

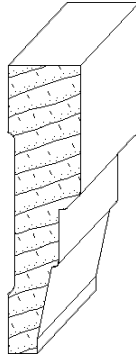

IH-391
5/8 x 2-1/2
chairrail_moulding

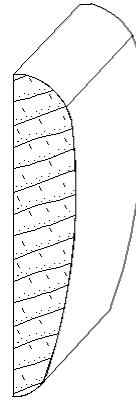

IH-396
1/2 x 2-1/2
chairrail_moulding

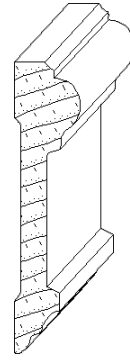

IH-304
5/8 x 2-5/8
chairrail_moulding

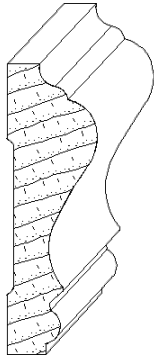

IH-387
13/16 x 2-5/8
chairrail_moulding

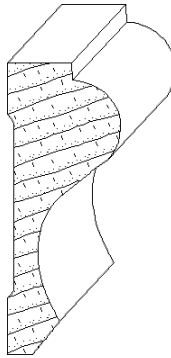

IH-301
1-1/16 x 2-3/4
chairrail_moulding

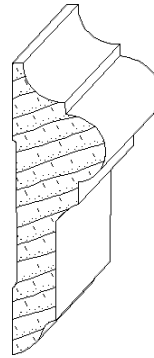

IH-302
7/8 x 2-3/4
chairrail_moulding

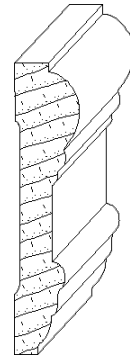

IH-308
5/8 x 2-3/4
chairrail_moulding

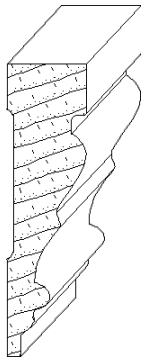

IH-344
3/4 x 2-3/4
chairrail_moulding

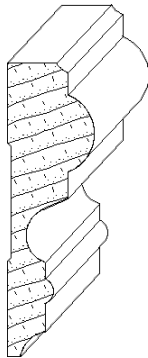

IH-355
13/16 x 2-3/4
chairrail_moulding

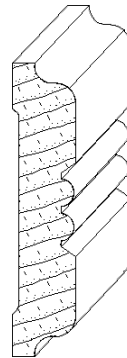

IH-372
9/16 x 2-3/4
chairrail_moulding

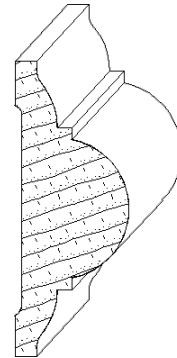

IH-317
1-1/8 x 2-7/8
chairrail_moulding



INTEGRITY
ARCHITECTURAL
MILLWORK, INC.

Quality Architectural
Wood Products

2503 Taylor Street
Omaha, NE 68111

(402) 451-4110

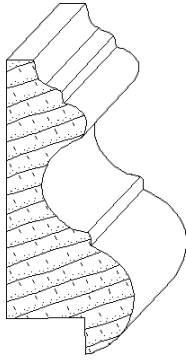

IH-350
1-1/4 x 2-7/8
chairrail_moulding



INTEGRITY
ARCHITECTURAL
MILLWORK, INC.

Quality Architectural
Wood Products

2503 Taylor Street
Omaha, NE 68111

(402) 451-4110

3" Chair Rail Moulding

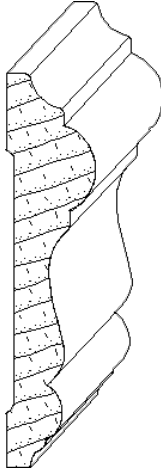

IH-342
11/16 x 3
chairrail_moulding

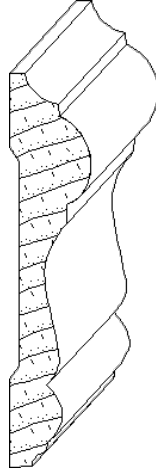

IH-351
5/8 x 3
chairrail_moulding

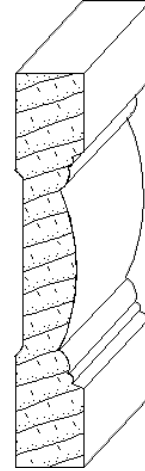

IH-367
1/2 x 3
chairrail_moulding

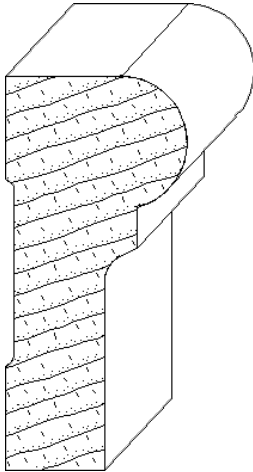

IH-393
1-3/8 x 3
chairrail_moulding

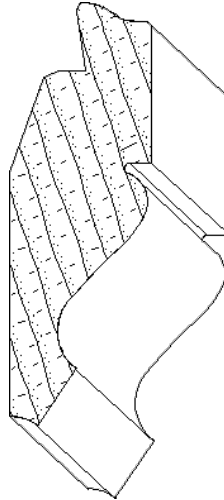

IH-1302
1 x 3
chairrail_moulding

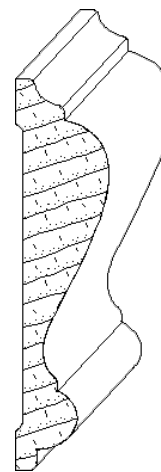

IH-324
3/4 x 3-1/8
chairrail_moulding



INTEGRITY
ARCHITECTURAL
MILLWORK, INC.

Quality Architectural
Wood Products

2503 Taylor Street
Omaha, NE 68111

(402) 451-4110

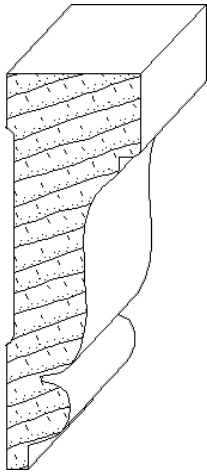

IH-335
1-1/16 x 3-1/8
chairrail_moulding

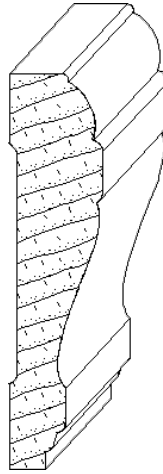

IH-361
3/4 x 3-1/8
chairrail_moulding

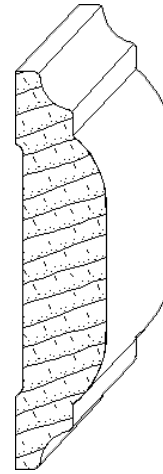

IH-334
3/4 x 3-1/4
chairrail_moulding

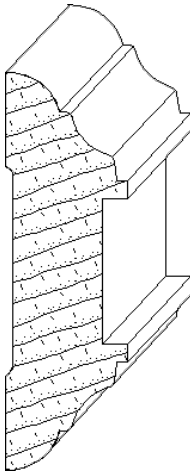

IH-336
1 x 3-1/4
chairrail_moulding

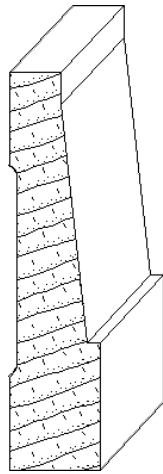

IH-343
3/4 x 3-1/4
chairrail_moulding

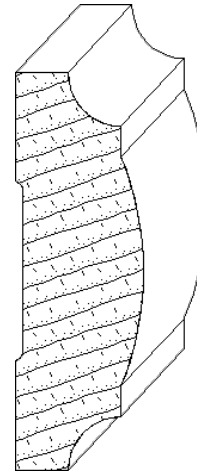

IH-373
1-1/16 x 3-1/4
chairrail_moulding

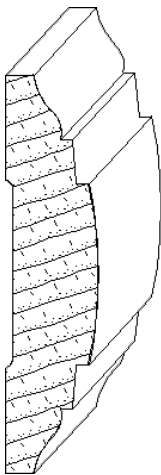

IH-380
3/4 x 3-1/4
chairrail_moulding

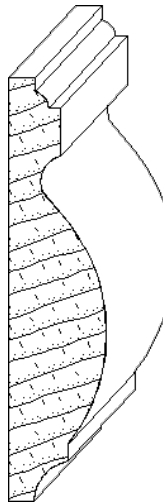

IH-399
3/4 x 3-1/4
chairrail_moulding

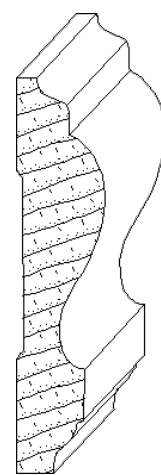

IH-323
3/4 x 3-3/8
chairrail_moulding



INTEGRITY
ARCHITECTURAL
MILLWORK, INC.

Quality Architectural
Wood Products

2503 Taylor Street
Omaha, NE 68111

(402) 451-4110

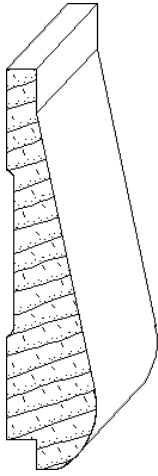

IH-390
3/4 x 3-3/8
chairrail_moulding

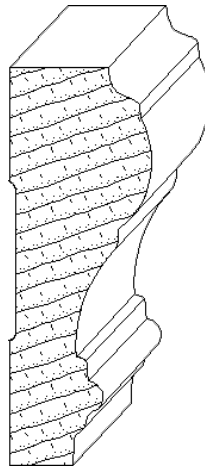

IH-319
1-1/4 x 3-1/2
chairrail_moulding

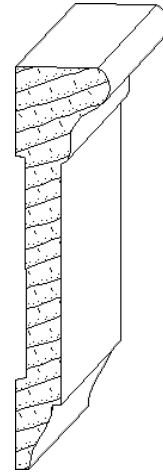

IH-346
13/16 x 3-1/2
chairrail_moulding

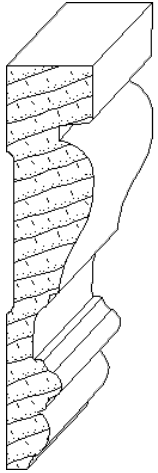

IH-354
3/4 x 3-1/2
chairrail_moulding

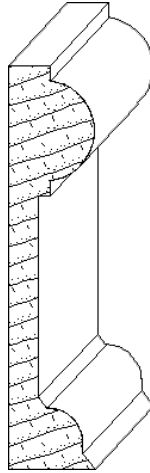

IH-382
3/4 x 3-1/2
chairrail_moulding

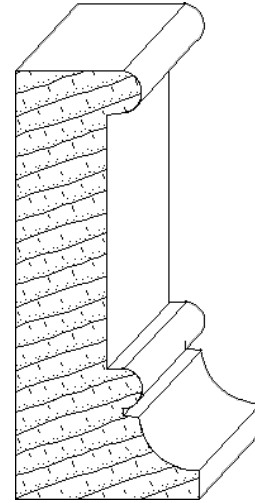

IH-397
1-1/2 x 3-1/2
chairrail_moulding

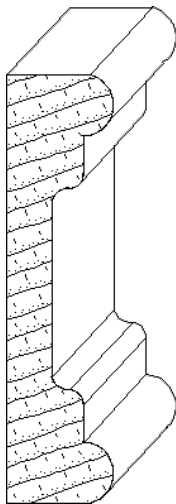

IH-398
7/8 x 3-1/2
chairrail_moulding

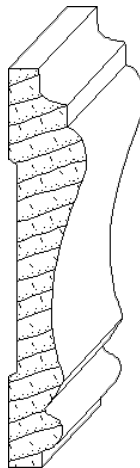

IH-327
11/16 x 3-9/16
chairrail_moulding

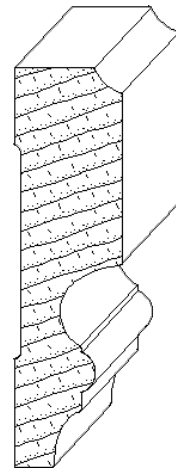

IH-322
1 x 3-5/8
chairrail_moulding



INTEGRITY
ARCHITECTURAL
MILLWORK, INC.

Quality Architectural
Wood Products

2503 Taylor Street
Omaha, NE 68111

(402) 451-4110

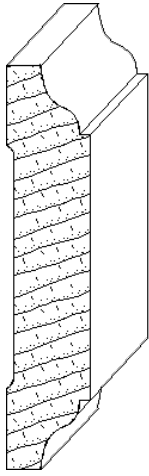

IH-364
3/4 x 3-5/8
chairrail_moulding

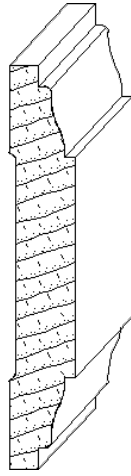

IH-370
9/16 x 3-5/8
chairrail_moulding

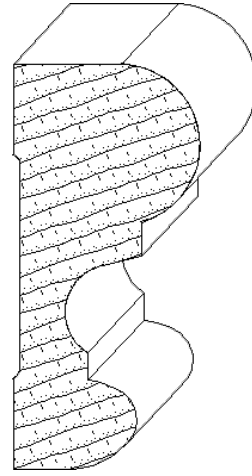

IH-392
1-11/16 x 3-11/16
chairrail_moulding

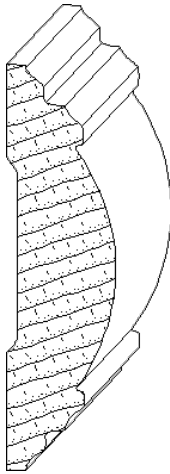

IH-347
1 x 3-3/4
chairrail_moulding



INTEGRITY
ARCHITECTURAL
MILLWORK, INC.

Quality Architectural
Wood Products

2503 Taylor Street
Omaha, NE 68111

(402) 451-4110

4" Chair Rail Moulding

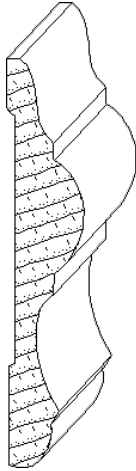

IH-325
13/16 x 4
chairrail_moulding

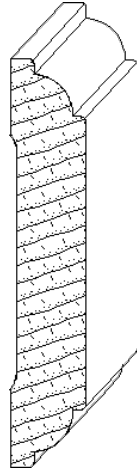

IH-326
3/4 x 4
chairrail_moulding

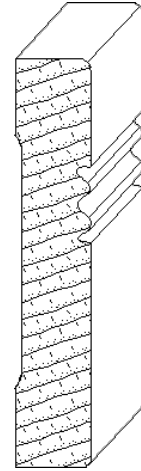

IH-330
3/4 x 4
chairrail_moulding

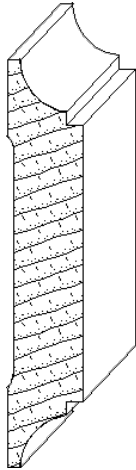

IH-333
3/4 x 4
chairrail_moulding

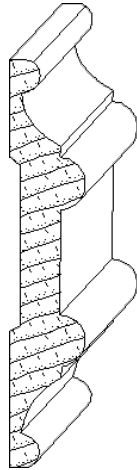

IH-337
3/4 x 4
chairrail_moulding

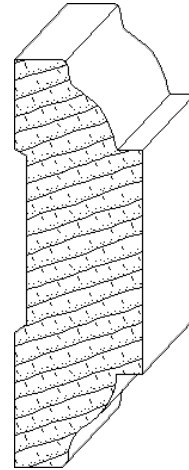

IH-341
1-1/4 x 4
chairrail_moulding



INTEGRITY
ARCHITECTURAL
MILLWORK, INC.

Quality Architectural
Wood Products

2503 Taylor Street
Omaha, NE 68111

(402) 451-4110

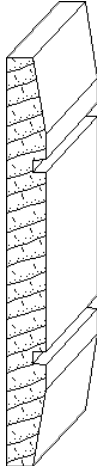

IH-389
3/8 x 4
chairrail_moulding

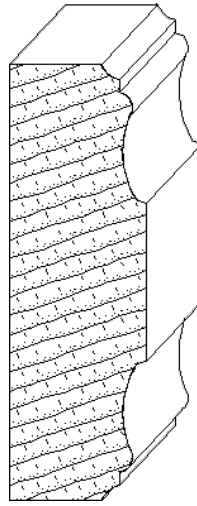

IH-395
1-1/4 x 4
chairrail_moulding

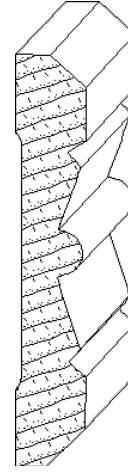

IH-314
3/4 x 4-1/4
chairrail_moulding

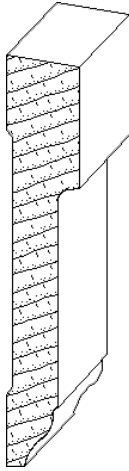

IH-371
3/4 x 4-1/4
chairrail_moulding

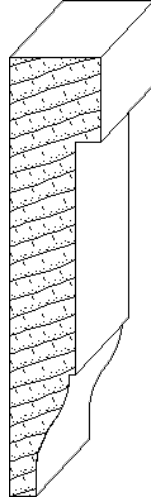

IH-1303
7/8 x 4-1/4
chairrail_moulding

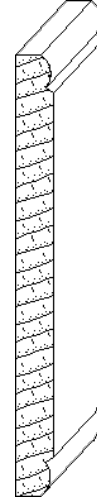

IH-1301
3/8 x 4-7/16
chairrail_moulding

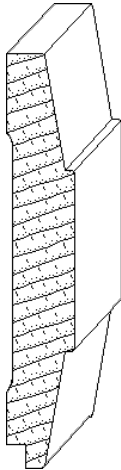

IH-312
3/4 x 4-1/2
chairrail_moulding

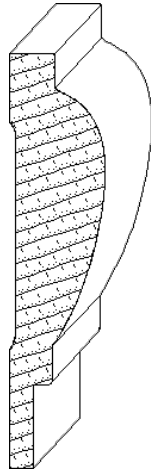

IH-356
1-1/16 x 4-9/16
chairrail_moulding



INTEGRITY
ARCHITECTURAL
MILLWORK, INC.

Quality Architectural
Wood Products

2503 Taylor Street
Omaha, NE 68111

(402) 451-4110

5+'' Chair Rail Moulding

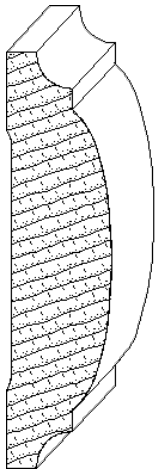

IH-379
1-1/4 x 5
chairrail_moulding

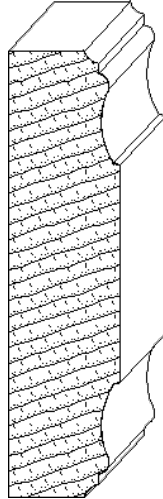

IH-394
1-1/4 x 5
chairrail_moulding

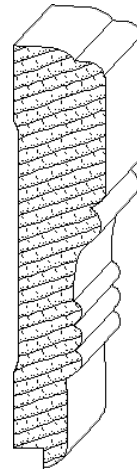

IH-340
1-1/4 x 5-3/4
chairrail_moulding

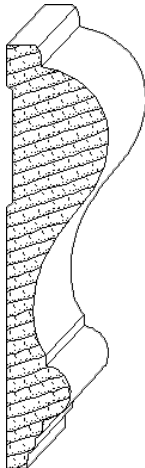

IH-352
1-3/8 x 5-3/4
chairrail_moulding

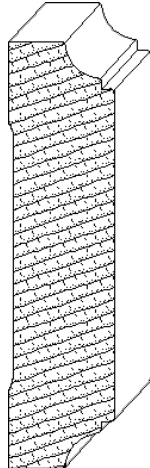

IH-338
1-1/2 x 6
chairrail_moulding

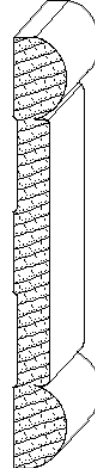

IH-321
13/16 x 6-1/2
chairrail_moulding

Chair Rail in the Size, Profile and Species You Need

To discuss your project needs, please call us at (402) 451-4110 or [contact us online](#).

Product images are generally to scale but are not shown at actual size.



INTEGRITY
ARCHITECTURAL
MILLWORK, INC.

Quality Architectural
Wood Products

2503 Taylor Street
Omaha, NE 68111

(402) 451-4110



Crown Mouldings

Solid wood crown moulding adds so much visual interest to a room! Integrity Architectural Millwork has hundreds of crown moulding profiles available and prepares all millwork to your specifications. Maple, Birch, Cherry, Red Oak and Poplar are kept on hand while hundreds, if not thousands, of other wood species can also be ordered.

Sizes: [1 inch](#) | [2 inch](#) | [3 inch](#) | [4 inch](#) | [5 inch](#) | [6 inch](#) | [7+ inch](#)

1" Crown Moulding

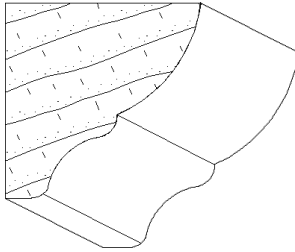

IH-1644
1 x 1
crown_moulding

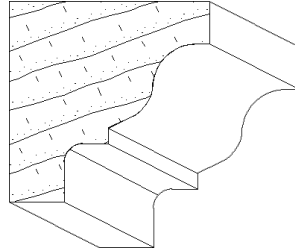

IH-1624
1-1/8 x 1-1/8
crown_moulding

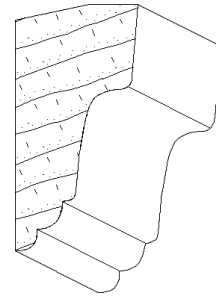

IH-675
3/4 x 1-1/2
crown_moulding

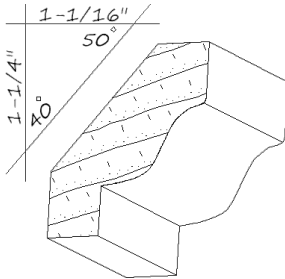

IH-682
1/2 x 1-5/8
crown_moulding

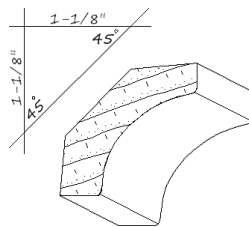

IH-688
9/16 x 1-5/8
crown_moulding

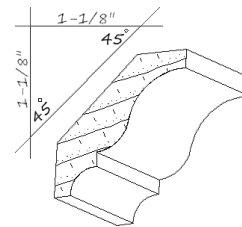

IH-1607
3/8 x 1-5/8
crown_moulding



INTEGRITY
ARCHITECTURAL
MILLWORK, INC.

Quality Architectural
Wood Products

2503 Taylor Street
Omaha, NE 68111

(402) 451-4110

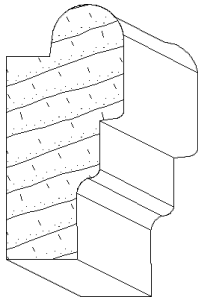

IH-1618
3/4 x 1-5/8
crown_moulding

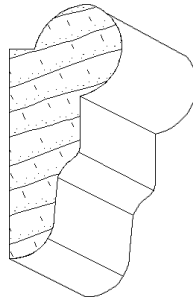
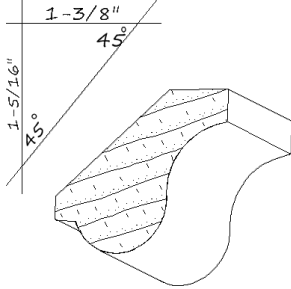

IH-1639
3/4 x 1-11/16
crown_moulding

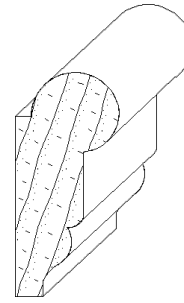
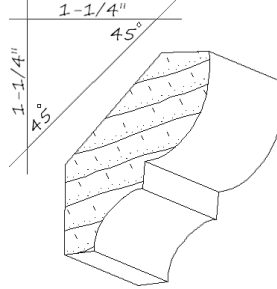

IH-1652
25/32 x 1-11/16
crown_moulding

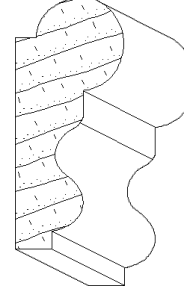

IH-1654
3/4 x 1-11/16
crown_moulding

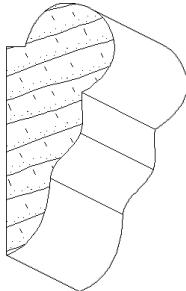

IH-617
9/16 x 1-3/4
crown_moulding

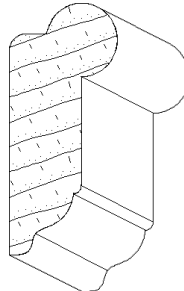

IH-619
3/4 x 1-3/4
crown_moulding

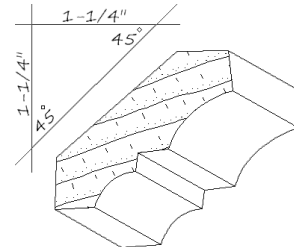

IH-624
3/4 x 1-3/4
crown_moulding

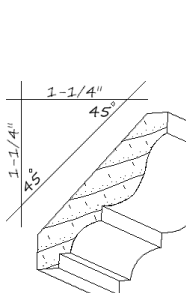

IH-626
3/4 x 1-3/4
crown_moulding

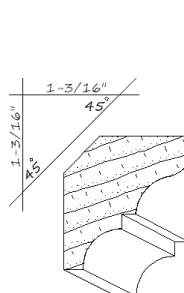

IH-653
1/2 x 1-3/4
crown_moulding

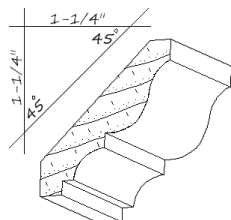
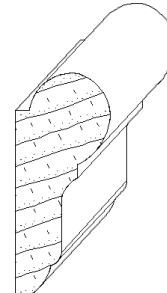

IH-687
3/8 x 1-3/4
crown_moulding

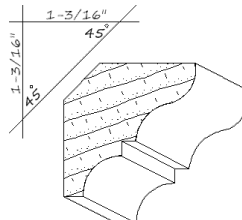

IH-1605
3/4 x 1-3/4
crown_moulding

IH-1643
3/4 x 1-3/4
crown_moulding



INTEGRITY
ARCHITECTURAL
MILLWORK, INC.

Quality Architectural
Wood Products

2503 Taylor Street
Omaha, NE 68111

(402) 451-4110

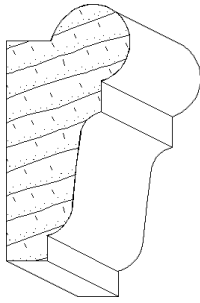

IH-1640
3/4 x 1-13/16
crown_moulding

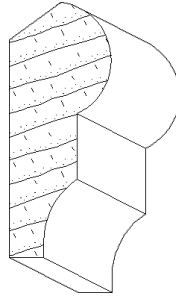

IH-1625
3/4 x 1-7/8
crown_moulding

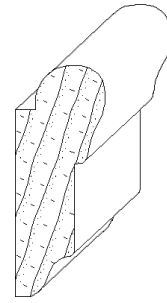

IH-1651
3/4 x 1-15/16
crown_moulding



INTEGRITY
ARCHITECTURAL
MILLWORK, INC.

Quality Architectural
Wood Products

2503 Taylor Street
Omaha, NE 68111

(402) 451-4110

2" Crown Moulding

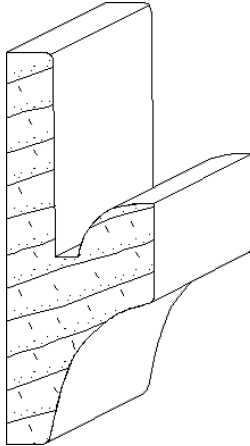

IH-677
3/4 x 2
crown_moulding

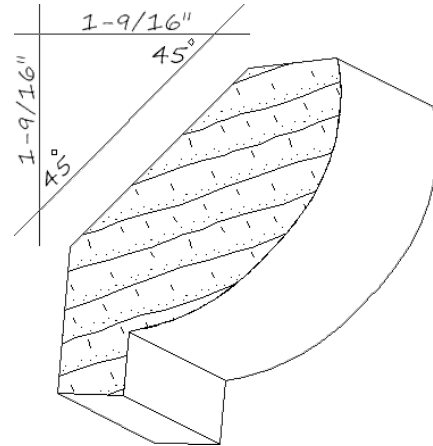

IH-605
3/4 x 2-1/4
crown_moulding

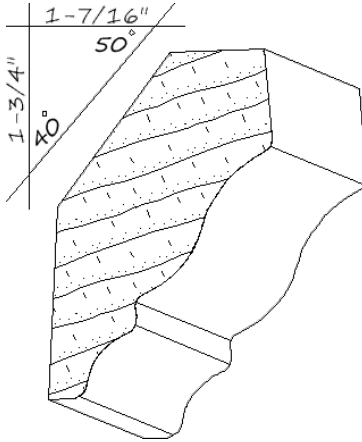

IH-618
3/4 x 2-1/4
crown_moulding

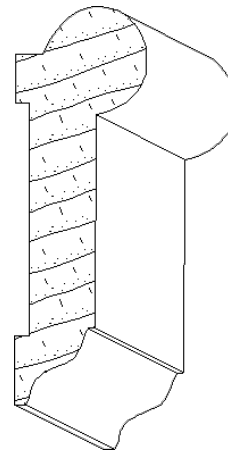

IH-627
3/4 x 2-1/4
crown_moulding

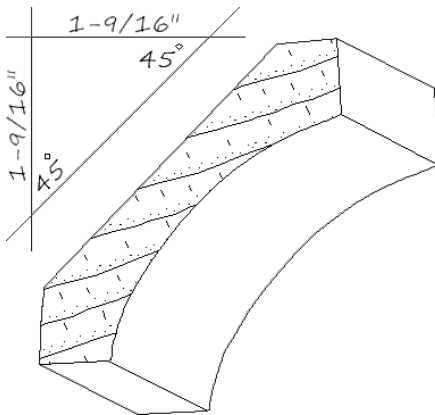

IH-692
1/2 x 2-1/4
crown_moulding

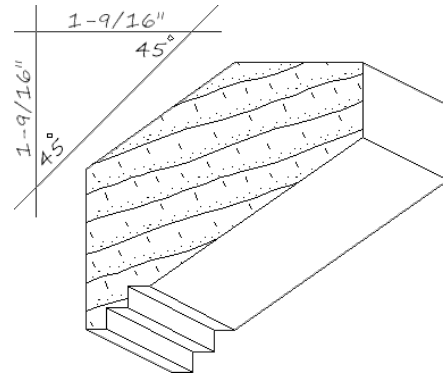

IH-1628
13/16 x 2-1/4
crown_moulding



INTEGRITY
ARCHITECTURAL
MILLWORK, INC.

Quality Architectural
Wood Products

2503 Taylor Street
Omaha, NE 68111

(402) 451-4110

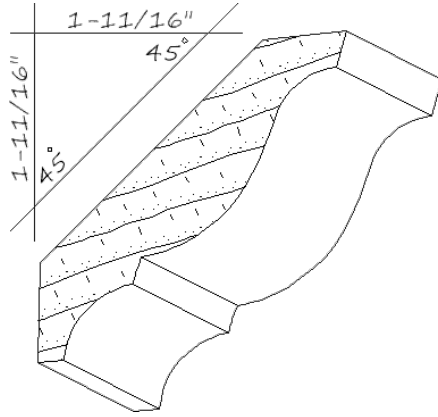

IH-620
1/2 x 2-3/8
crown_moulding

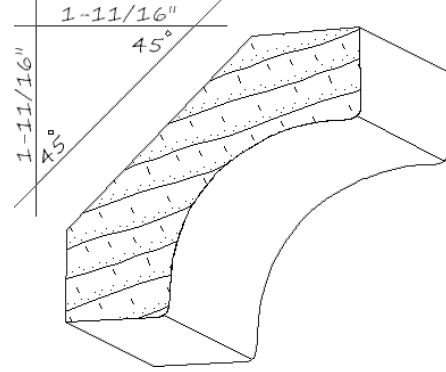

IH-669
3/4 x 2-3/8
crown_moulding

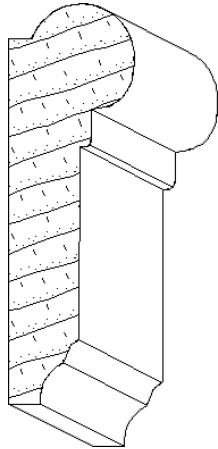

IH-1632
3/4 x 2-3/8
crown_moulding

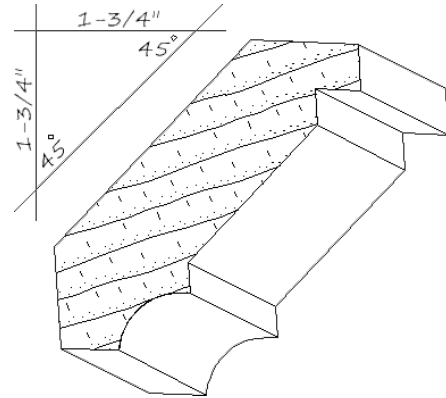

IH-658
3/4 x 2-7/16
crown_moulding

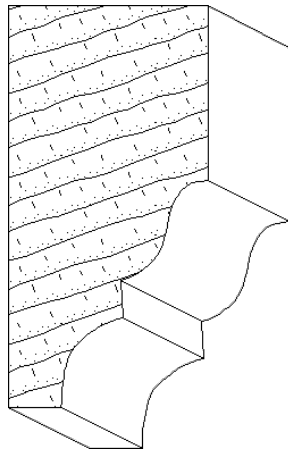

IH-672
1-1/4 x 2-1/2
crown_moulding

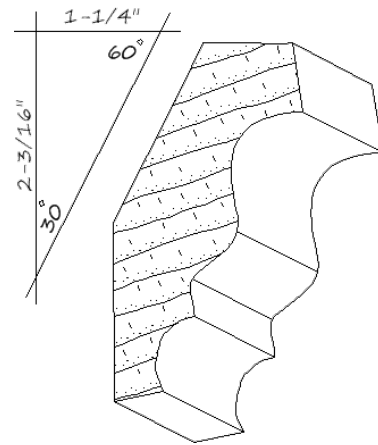

IH-681
3/4 x 2-1/2
crown_moulding



INTEGRITY
ARCHITECTURAL
MILLWORK, INC.

Quality Architectural
Wood Products

2503 Taylor Street
Omaha, NE 68111

(402) 451-4110

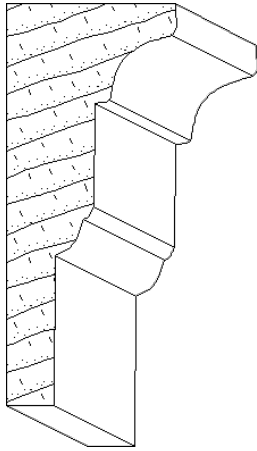

IH-685
1-1/16 x 2-1/2
crown_moulding

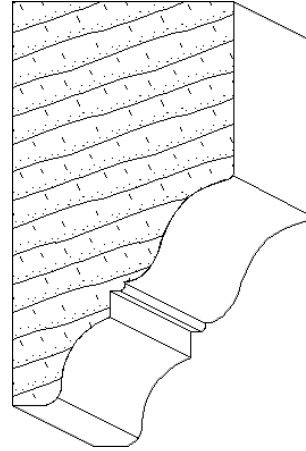

IH-1656
1-3/8 x 2-1/2
crown_moulding

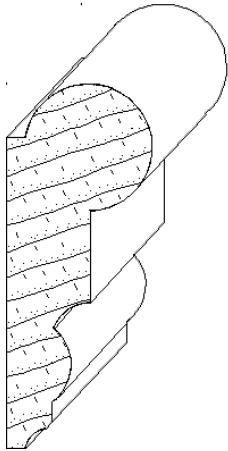

IH-1659
1 x 2-1/2
crown_moulding

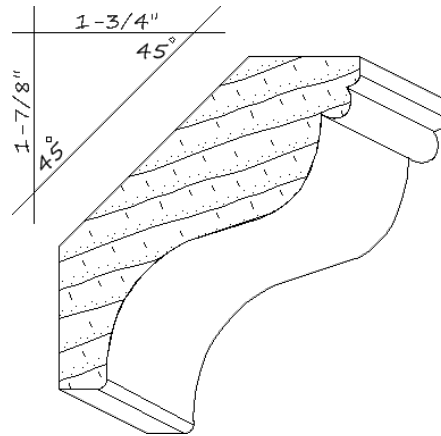

IH-1646
3/4 x 2-9/16
crown_moulding

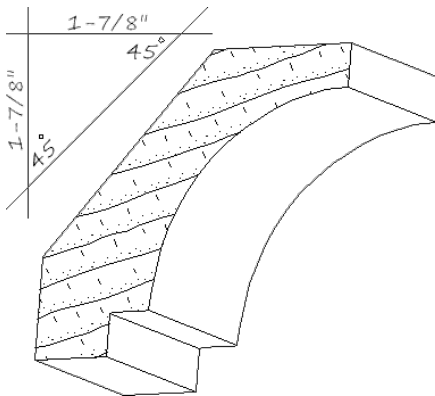

IH-625
3/4 x 2-5/8
crown_moulding

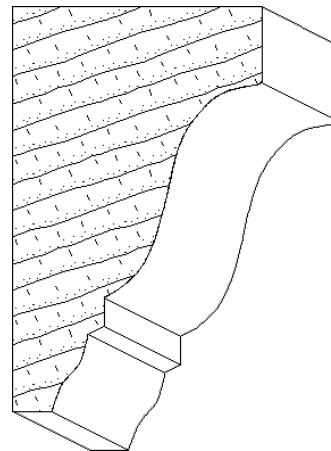

IH-697
1-5/8 x 2-5/8
crown_moulding



INTEGRITY
ARCHITECTURAL
MILLWORK, INC.

Quality Architectural
Wood Products

2503 Taylor Street
Omaha, NE 68111

(402) 451-4110

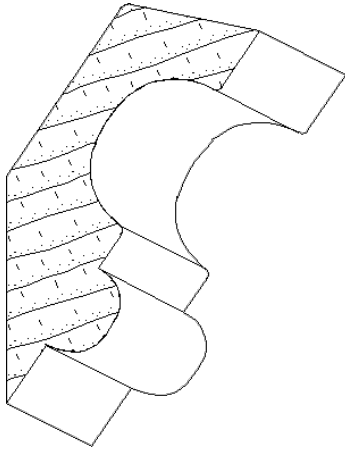

IH-1612
1 x 2-5/8
crown_moulding

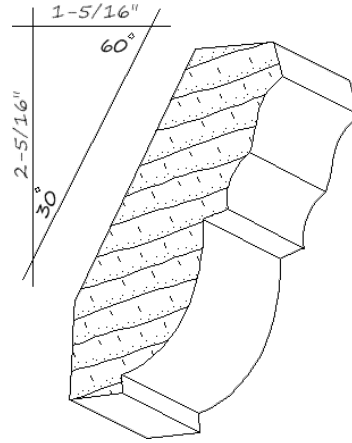

IH-655
11/16 x 2-11/16
crown_moulding

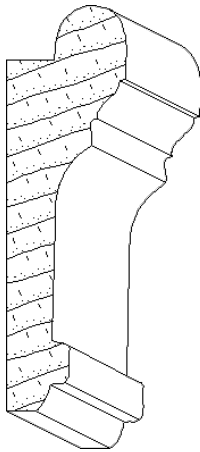

IH-601
13/16 x 2-3/4
crown_moulding

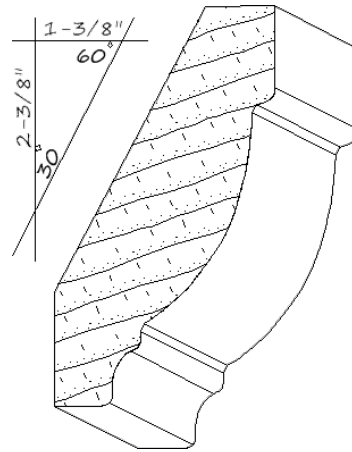

IH-629
3/4 x 2-3/4
crown_moulding

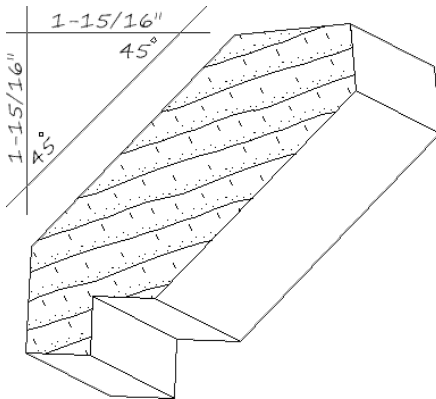

IH-684
3/4 x 2-3/4
crown_moulding

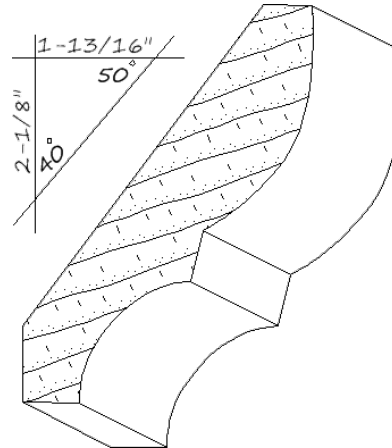

IH-628
5/8 x 2-13/16
crown_moulding



INTEGRITY
ARCHITECTURAL
MILLWORK, INC.

Quality Architectural
Wood Products

2503 Taylor Street
Omaha, NE 68111

(402) 451-4110

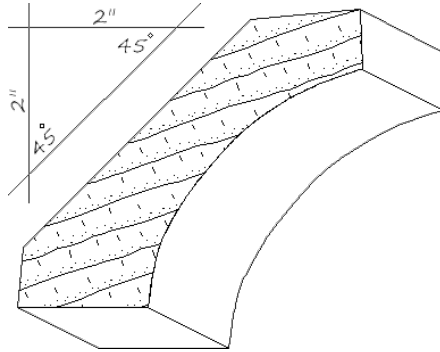

IH-691
13/16 x 2-13/16
crown_moulding

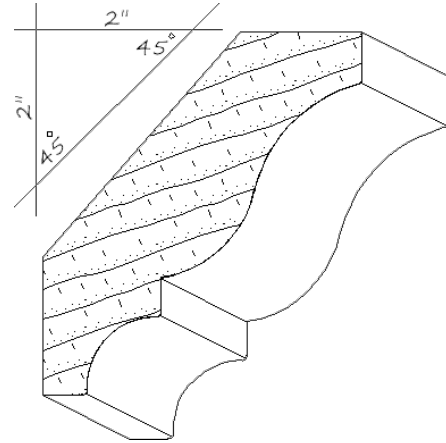

IH-1619
3/4 x 2-13/16
crown_moulding

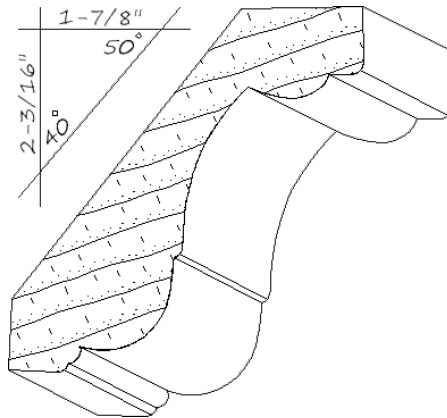

IH-623
3/4 x 2-7/8
crown_moulding

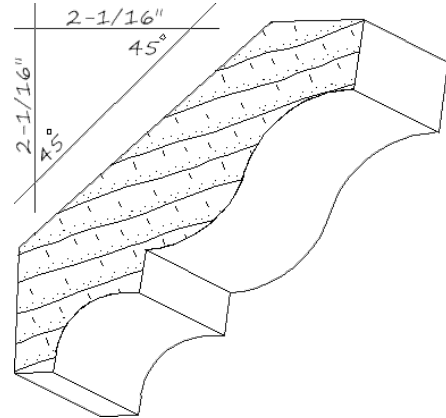

IH-1604
11/16 x 2-15/16
crown_moulding



INTEGRITY
ARCHITECTURAL
MILLWORK, INC.

Quality Architectural
Wood Products

2503 Taylor Street
Omaha, NE 68111

(402) 451-4110

3" Crown Moulding

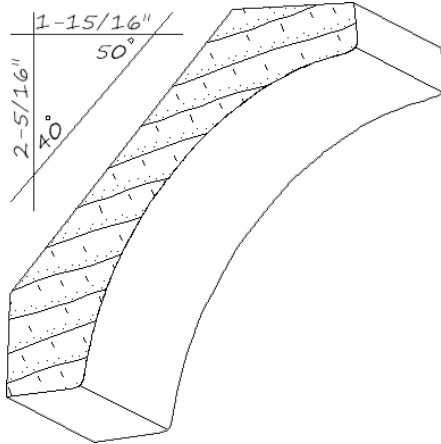

IH-603
11/16 x 3
crown_moulding

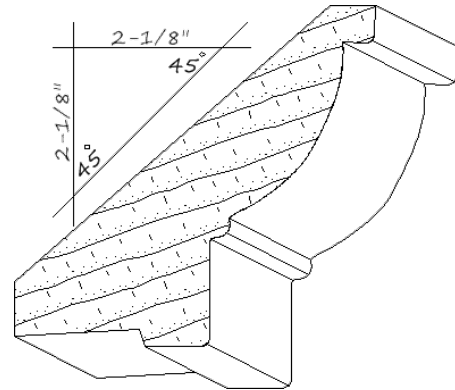

IH-609
1-1/16 x 3
crown_moulding

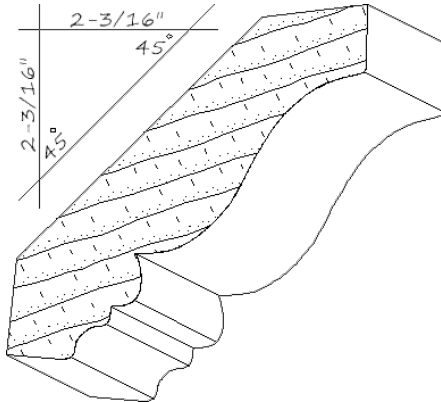

IH-612
11/16 x 3-1/16
crown_moulding

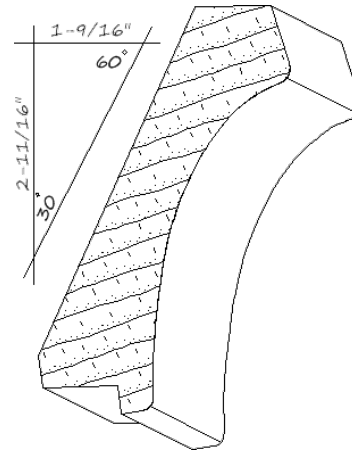

IH-616
7/8 x 3-1/8
crown_moulding

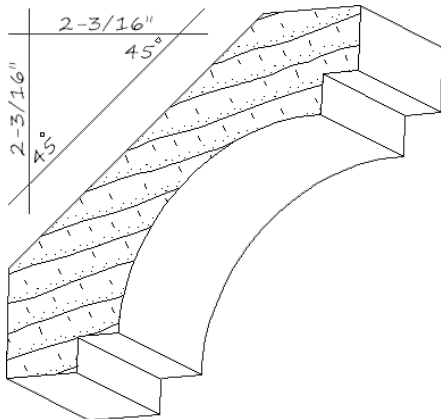

IH-635
3/4 x 3-1/8
crown_moulding

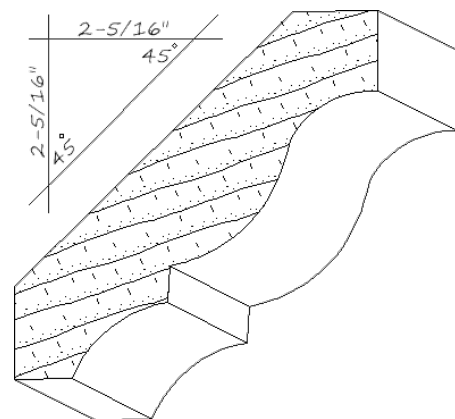

IH-630
3/4 x 3-1/4
crown_moulding



INTEGRITY
ARCHITECTURAL
MILLWORK, INC.

Quality Architectural
Wood Products

2503 Taylor Street
Omaha, NE 68111

(402) 451-4110

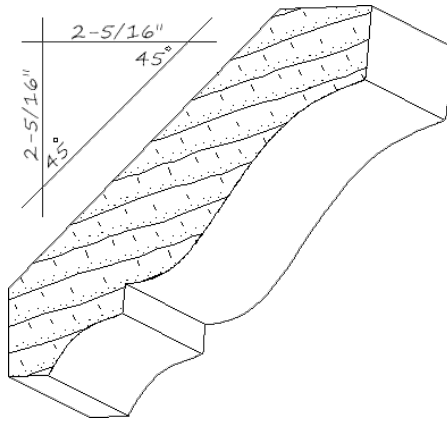

IH-632
11/16 x 3-1/4
crown_moulding

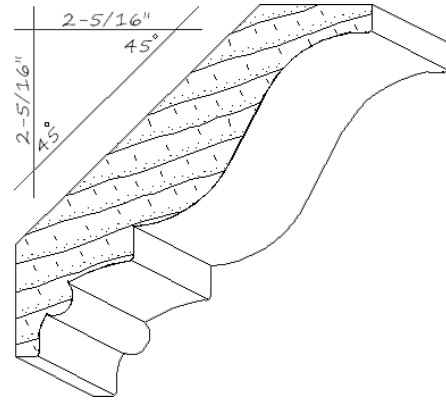

IH-644
5/8 x 3-1/4
crown_moulding

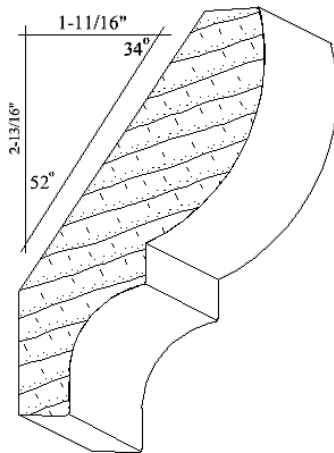

IH-1657
3/4 x 3-1/4
crown_moulding

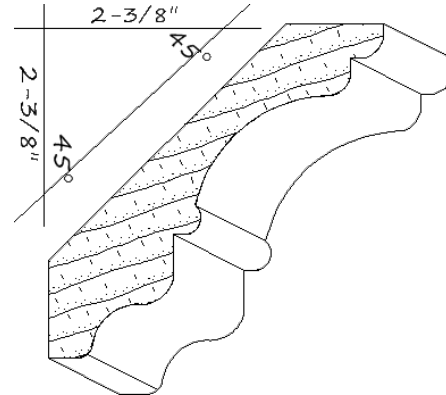

IH-1658
3/4 x 3-3/8
crown_moulding

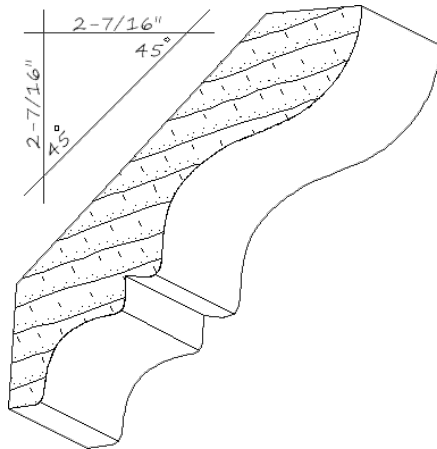

IH-636
5/8 x 3-7/16
crown_moulding

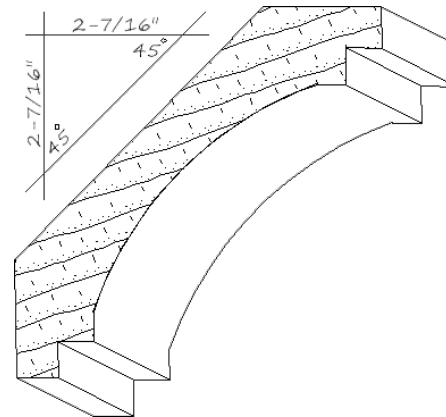

IH-1601
3/4 x 3-7/16
crown_moulding



INTEGRITY
ARCHITECTURAL
MILLWORK, INC.

Quality Architectural
Wood Products

2503 Taylor Street
Omaha, NE 68111

(402) 451-4110

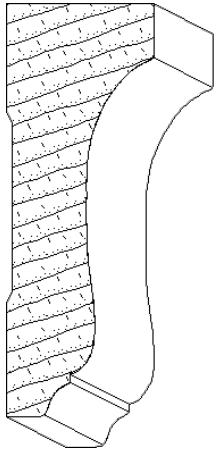

IH-638
1-1/4 x 3-1/2
crown_moulding

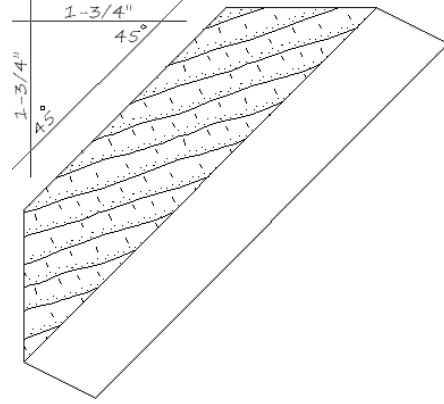

IH-641
3/4 x 3-1/2
crown_moulding

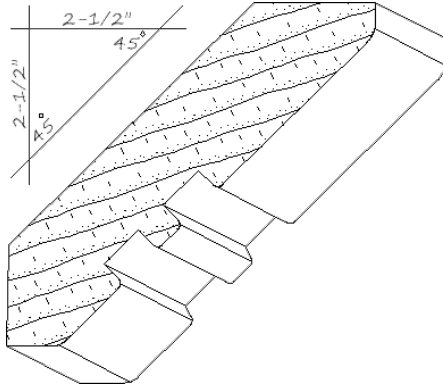

IH-643
3/4 x 3-1/2
crown_moulding

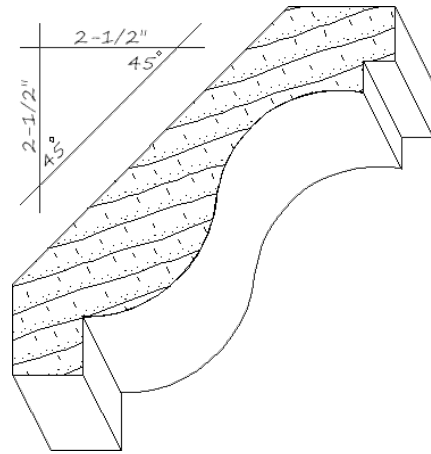

IH-1622
3/4 x 3-1/2
crown_moulding

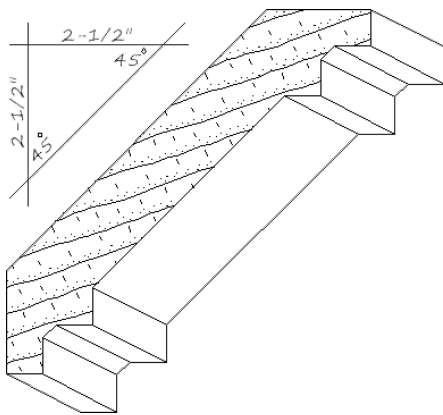

IH-1633
11/16 x 3-1/2
crown_moulding

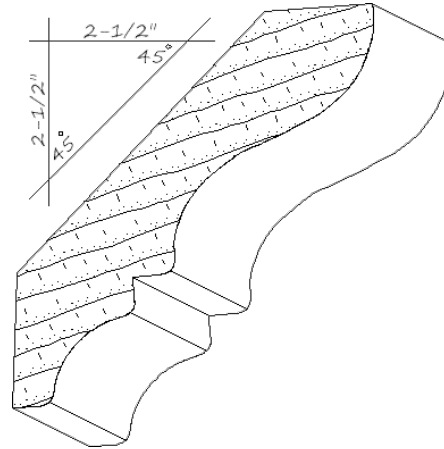

IH-610
3/4 x 3-9/16
crown_moulding



INTEGRITY
ARCHITECTURAL
MILLWORK, INC.

Quality Architectural
Wood Products

2503 Taylor Street
Omaha, NE 68111

(402) 451-4110

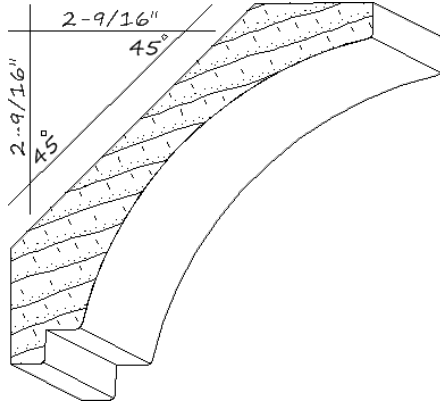

IH-1650
3/4 x 3-5/8
crown_moulding

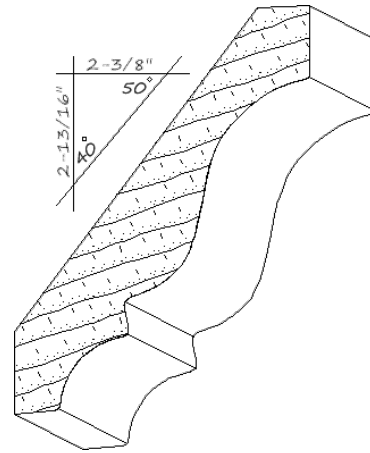

IH-600
11/16 x 3-11/16
crown_moulding

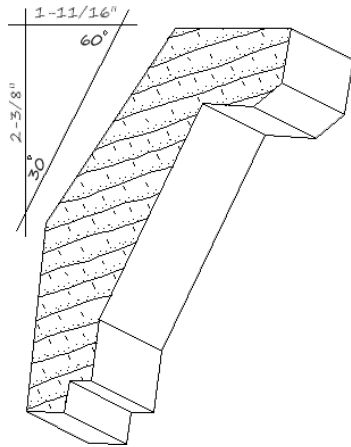

IH-666
1 x 3-3/4
crown_moulding

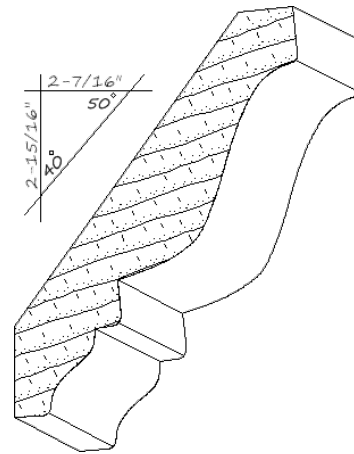

IH-613
3/4 x 3-13/16
crown_moulding

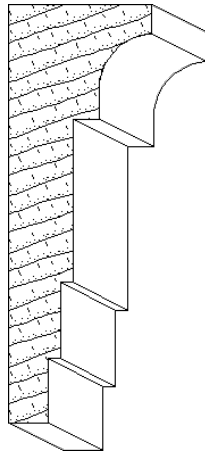

IH-1642
1-5/16 x 3-13/16
crown_moulding

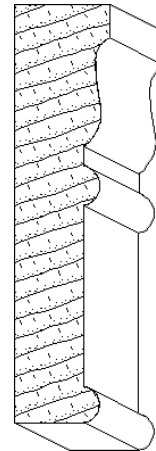

IH-1649
7/8 x 3-13/16
crown_moulding



INTEGRITY
ARCHITECTURAL
MILLWORK, INC.

Quality Architectural
Wood Products

2503 Taylor Street
Omaha, NE 68111

(402) 451-4110

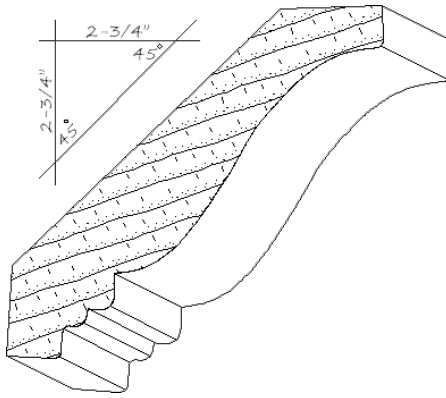

IH-696

3/4 x 3-7/8
crown_moulding



INTEGRITY
ARCHITECTURAL
MILLWORK, INC.

Quality Architectural
Wood Products

2503 Taylor Street
Omaha, NE 68111

(402) 451-4110

4" Crown Moulding

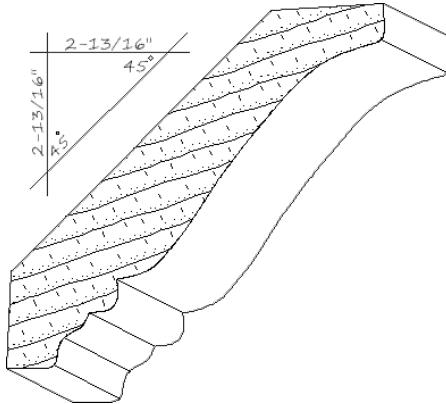

IH-621
3/4 x 4
crown_moulding

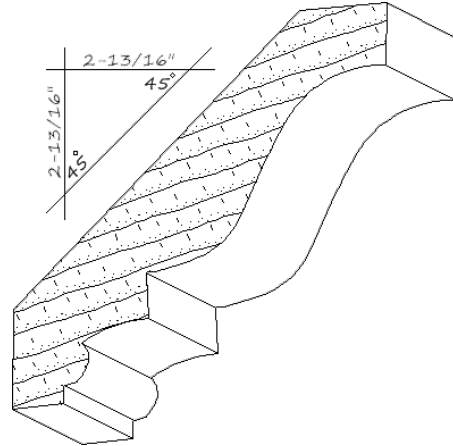

IH-640
3/4 x 4
crown_moulding

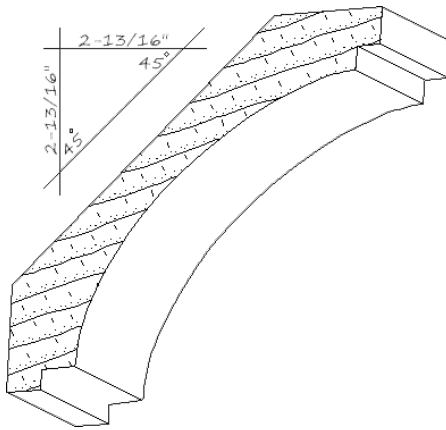

IH-657
3/4 x 4
crown_moulding

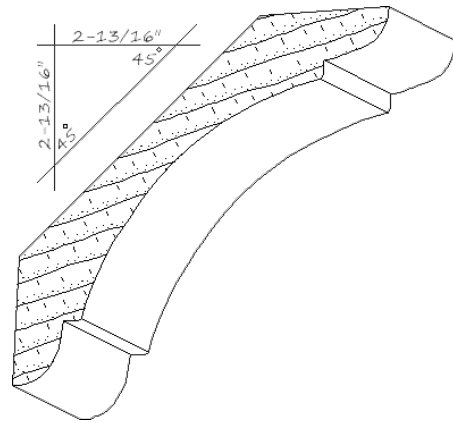

IH-686
3/4 x 4
crown_moulding

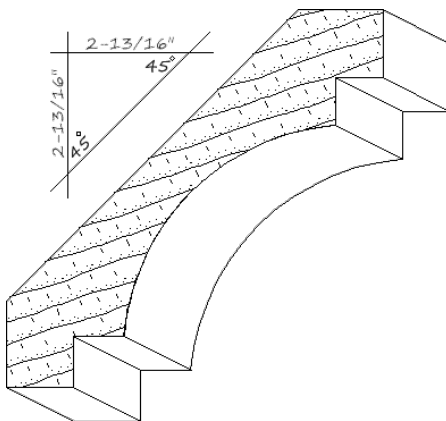

IH-1609
13/16 x 4
crown_moulding

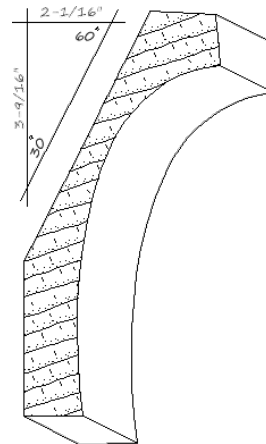

IH-693
1-1/8 x 4-1/8
crown_moulding



INTEGRITY
ARCHITECTURAL
MILLWORK, INC.

Quality Architectural
Wood Products

2503 Taylor Street
Omaha, NE 68111

(402) 451-4110

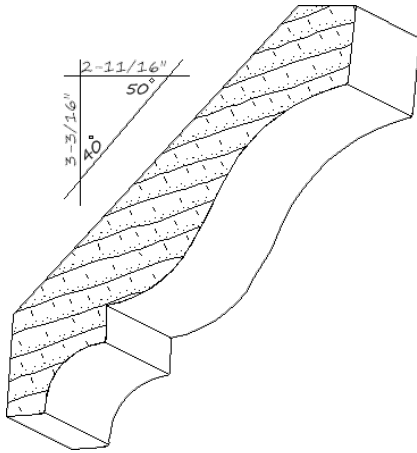

IH-1626
1 1/16 x 4-3/16
crown_moulding

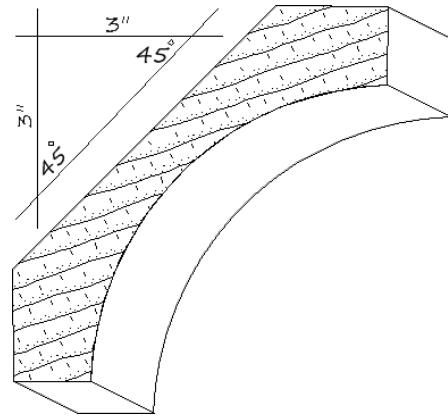

IH-1645
1-1/16 x 4-3/16
crown_moulding

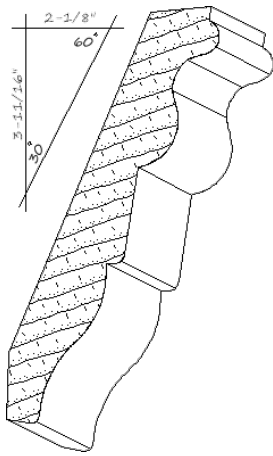

IH-639
1 1/16 x 4-1/4
crown_moulding

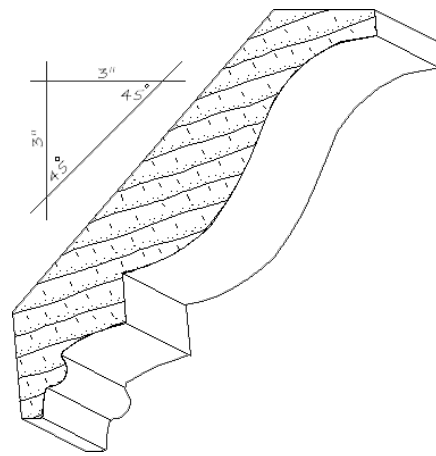

IH-642
3/4 x 4-1/4
crown_moulding

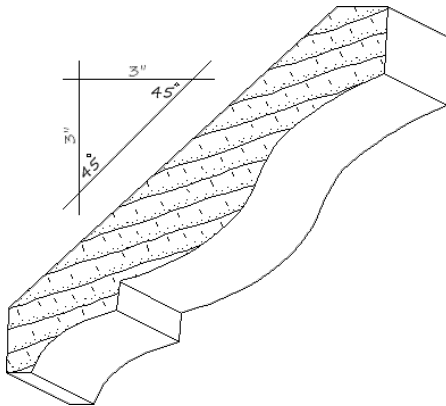

IH-645
1 1/16 x 4-1/4
crown_moulding

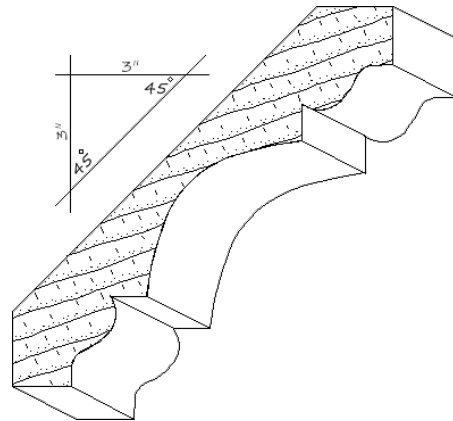

IH-659
3/4 x 4-1/4
crown_moulding



INTEGRITY
ARCHITECTURAL
MILLWORK, INC.

Quality Architectural
Wood Products

2503 Taylor Street
Omaha, NE 68111

(402) 451-4110

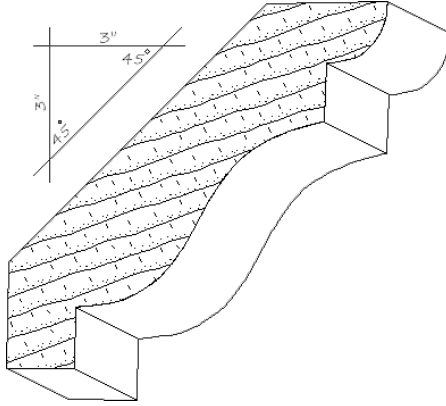

IH-695
1 x 4-1/4
crown_moulding

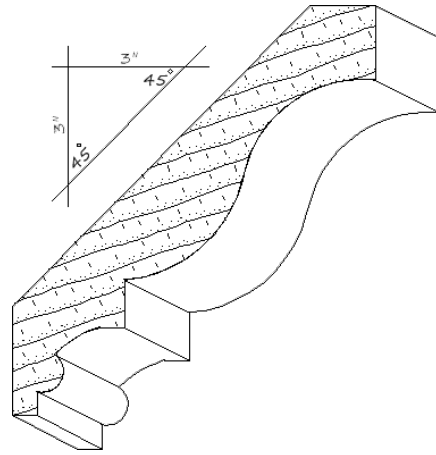

IH-1603
5/8 x 4-1/4
crown_moulding

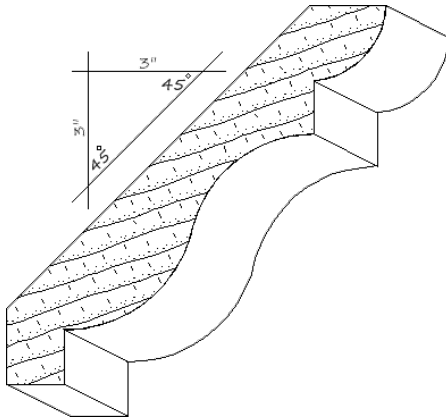

IH-1621
3/4 x 4-1/4
crown_moulding

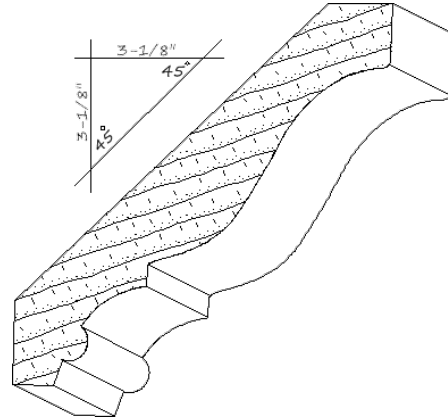

IH-608
3/4 x 4-3/8
crown_moulding

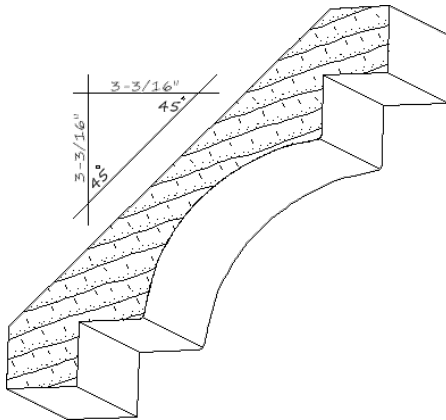

IH-652
3/4 x 4-1/2
crown_moulding

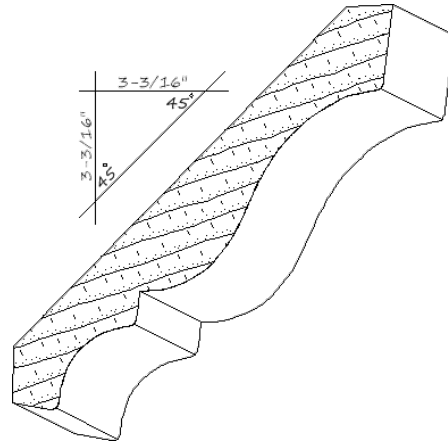

IH-683
11/16 x 4-1/2
crown_moulding



INTEGRITY
ARCHITECTURAL
MILLWORK, INC.

Quality Architectural
Wood Products

2503 Taylor Street
Omaha, NE 68111

(402) 451-4110

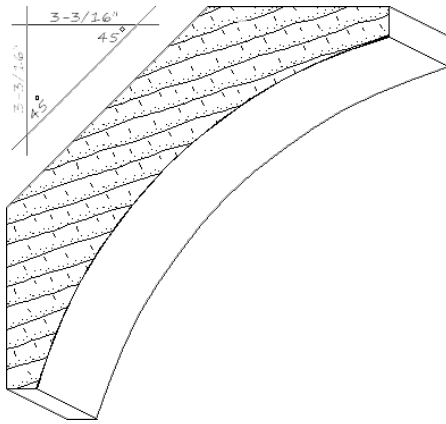

IH-1631
1-1/4 x 4-1/2
crown_moulding

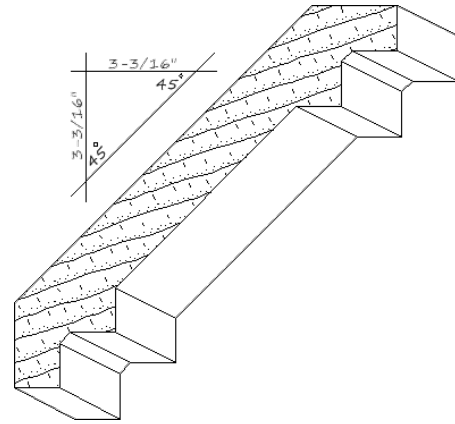

IH-1634
3/4 x 4-1/2
crown_moulding

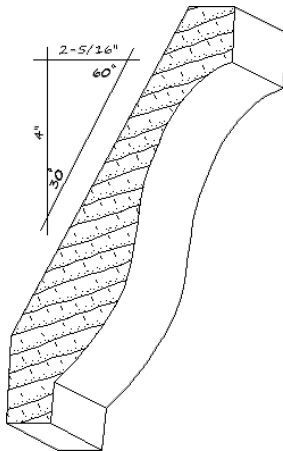

IH-647
3/4 x 4-5/8
crown_moulding

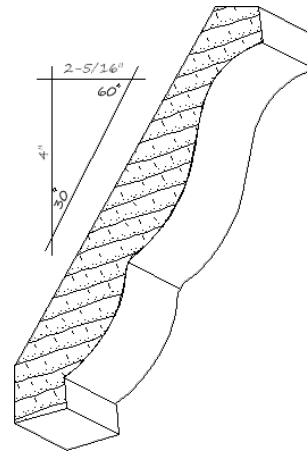

IH-1600
5/8 x 4-5/8
crown_moulding

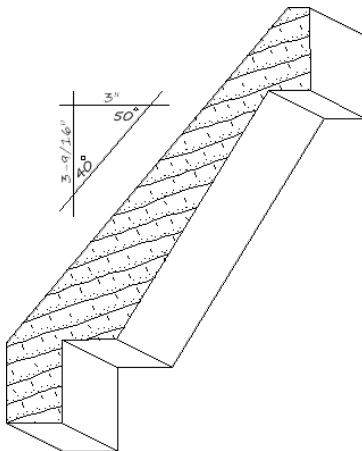

IH-1616
7/8 x 4-5/8
crown_moulding

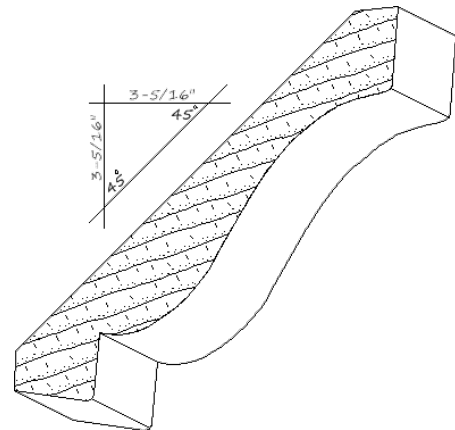

IH-615
3/4 x 4-11/16
crown_moulding



INTEGRITY
ARCHITECTURAL
MILLWORK, INC.

Quality Architectural
Wood Products

2503 Taylor Street
Omaha, NE 68111

(402) 451-4110

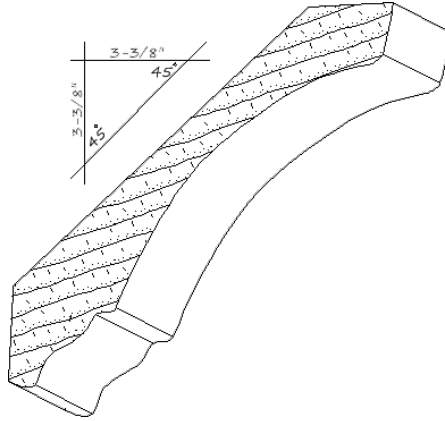

IH-606

3/4 x 4-3/4
crown_moulding

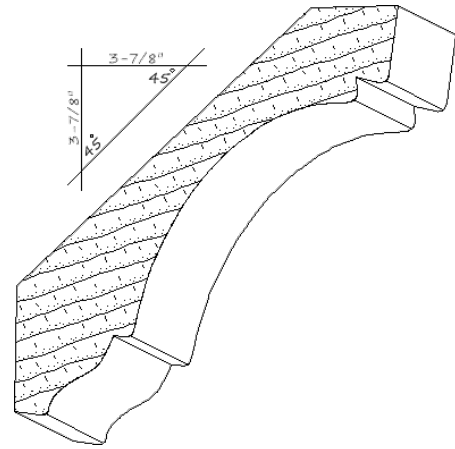

IH-667

1 x 4-7/8
crown_moulding

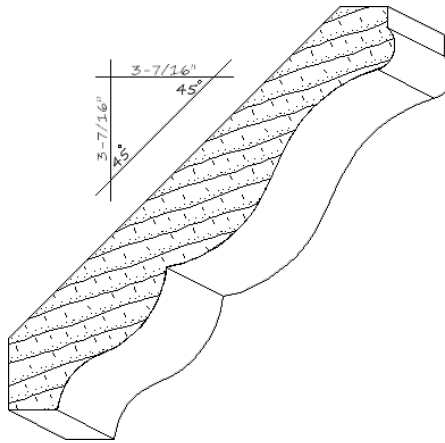

IH-1623

3/4 x 4-7/8
crown_moulding



INTEGRITY
ARCHITECTURAL
MILLWORK, INC.

Quality Architectural
Wood Products

2503 Taylor Street
Omaha, NE 68111

(402) 451-4110

5" Crown Moulding

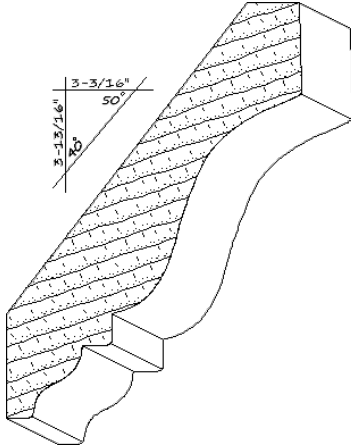

IH-637

1 x 5
crown_moulding

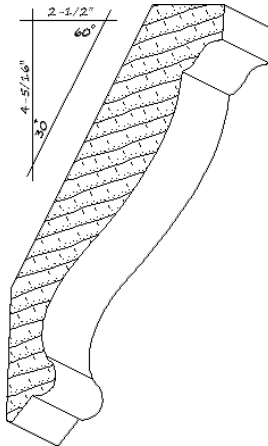

IH-664

7/8 x 5
crown_moulding

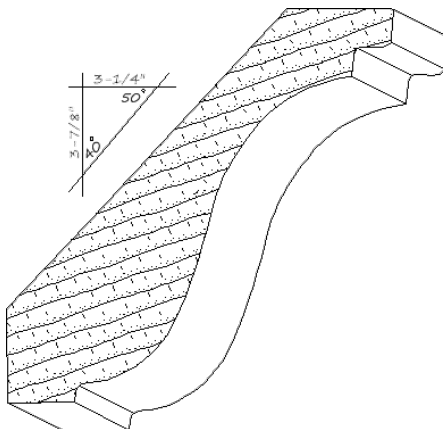

IH-698

1-1/4 x 5-1/16
crown_moulding

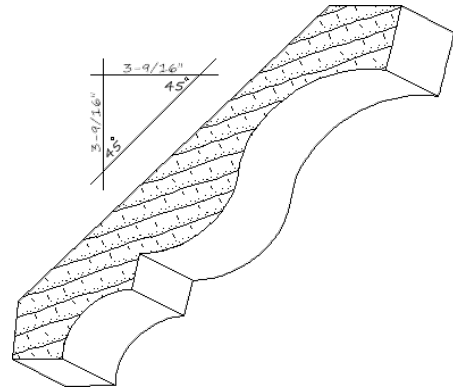

IH-650

13/16 x 5
crown_moulding

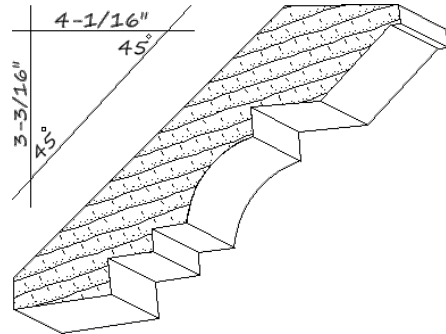

IH-1602

1 x 5-1/8
crown_moulding

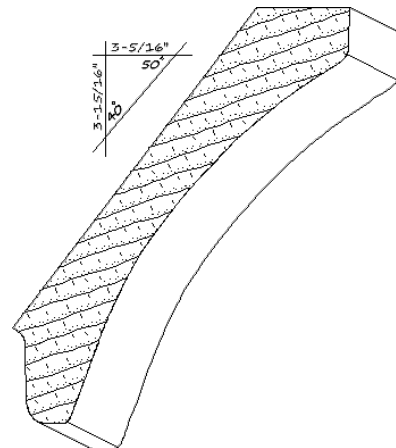

IH-660

1 x 5-1/8
crown_moulding



INTEGRITY
ARCHITECTURAL
MILLWORK, INC.

Quality Architectural
Wood Products

2503 Taylor Street
Omaha, NE 68111

(402) 451-4110

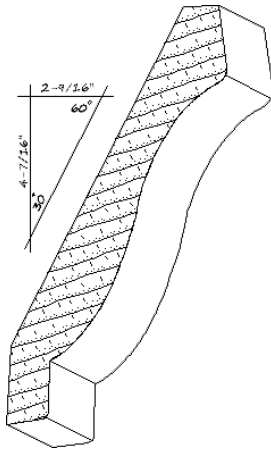

IH-690
3/4 x 5-1/8
crown_moulding

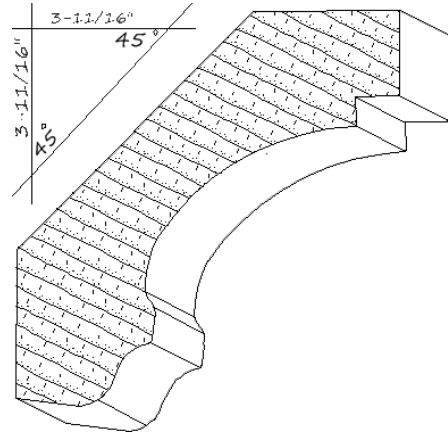

IH-1617
1-9/16 x 5-3/16
crown_moulding

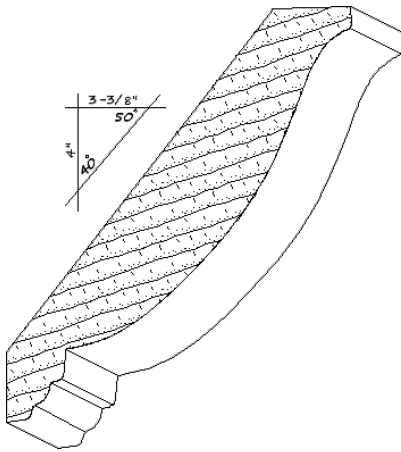

IH-633
1 x 5-1/4
crown_moulding

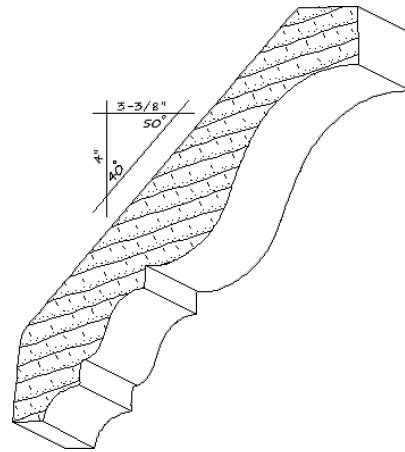

IH-673
13/16 x 5-1/4
crown_moulding

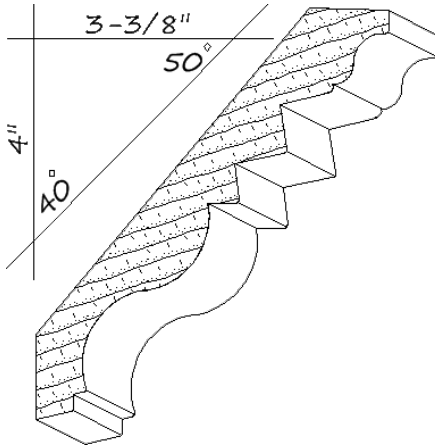

IH-1610
3/4 x 5-1/4
crown_moulding

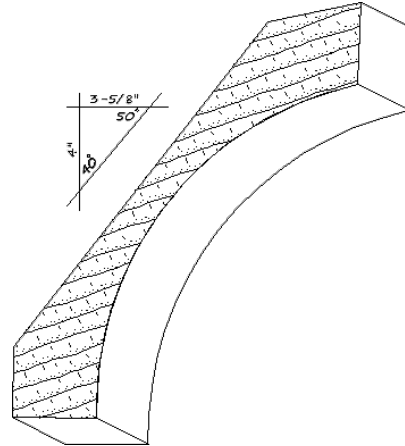

IH-1636
1-1/16 x 5-1/4
crown_moulding



INTEGRITY
ARCHITECTURAL
MILLWORK, INC.

Quality Architectural
Wood Products

2503 Taylor Street
Omaha, NE 68111

(402) 451-4110

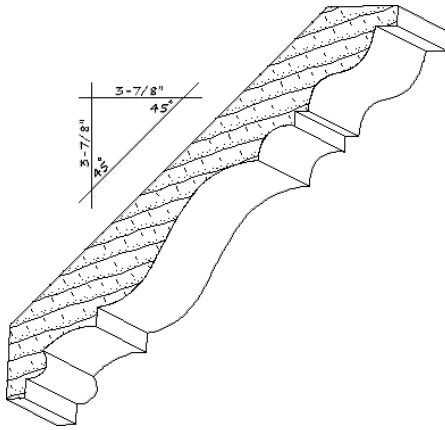

IH-648
5/8 x 5-1/2
crown_moulding

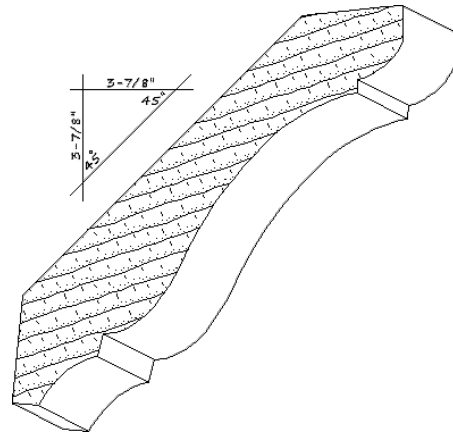

IH-662
1 x 5-1/2
crown_moulding

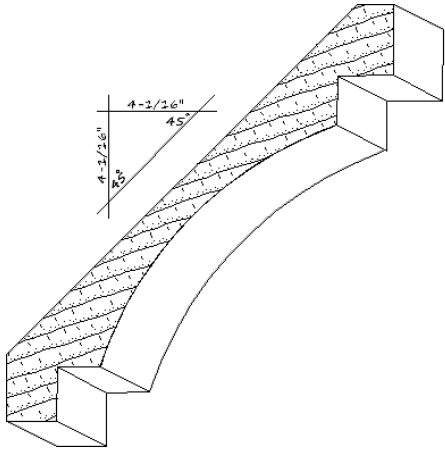

IH-646
13/16 x 5-3/4
crown_moulding

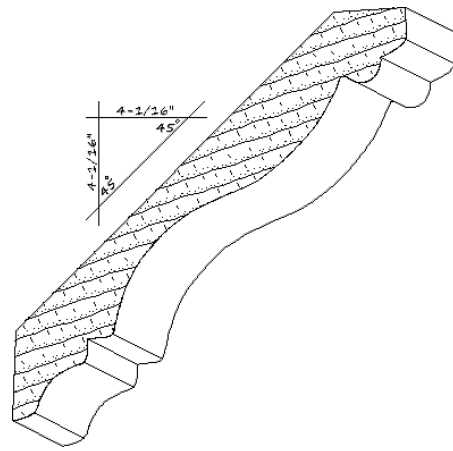

IH-656
3/4 x 5-3/4
crown_moulding

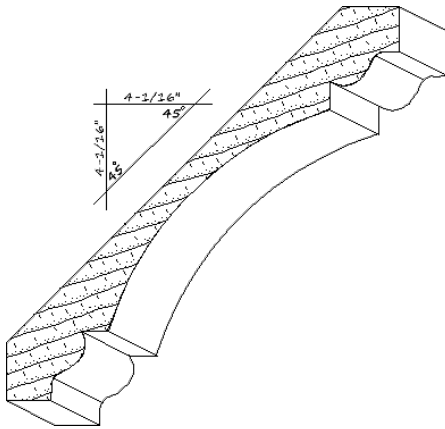

IH-661
3/4 x 5-3/4
crown_moulding

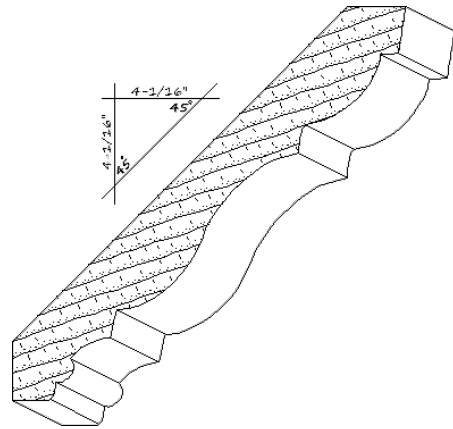

IH-663
3/4 x 5-3/4
crown_moulding



INTEGRITY
ARCHITECTURAL
MILLWORK, INC.

Quality Architectural
Wood Products

2503 Taylor Street
Omaha, NE 68111

(402) 451-4110

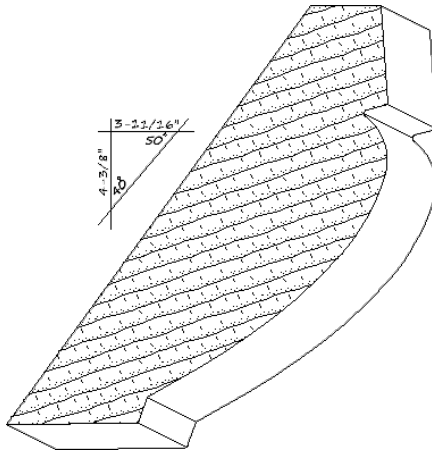

IH-1615
1-3/4 x 5-3/4
crown_moulding

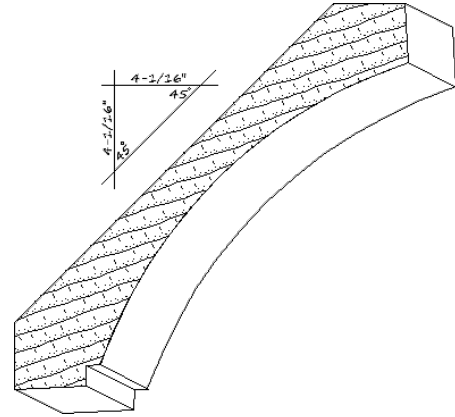

IH-1627
1 x 5-3/4
crown_moulding

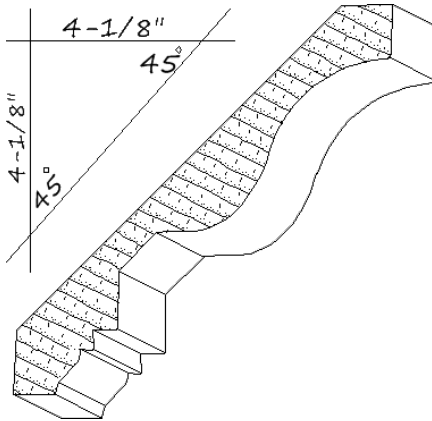

IH-1637
3/4 x 5-3/4
crown_moulding

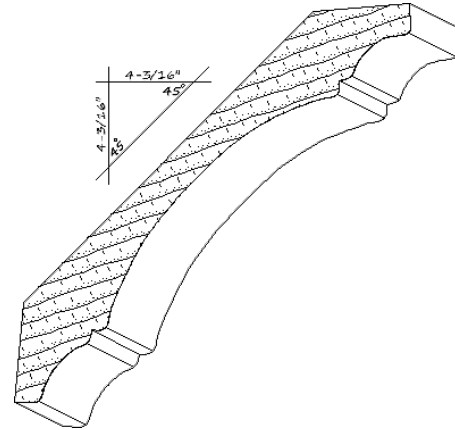

IH-614
7/8 x 5-15/16
crown_moulding

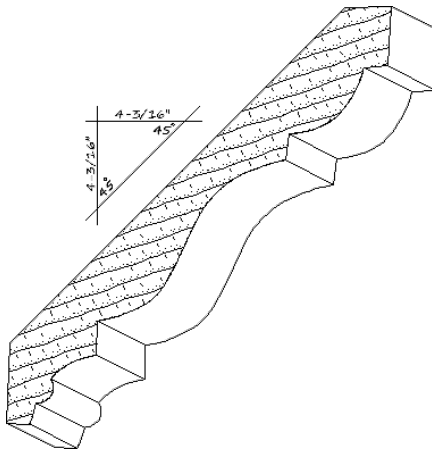

IH-668
3/4 x 5-15/16
crown_moulding

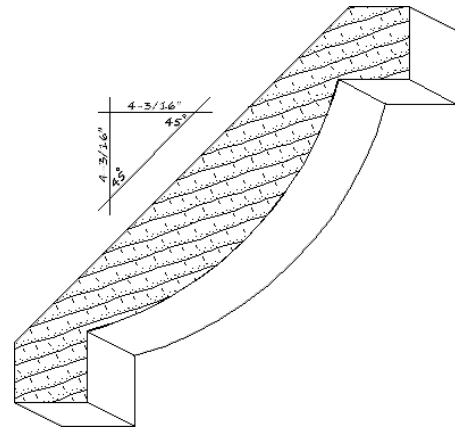

IH-1638
1 x 5-15/16
crown_moulding



INTEGRITY
ARCHITECTURAL
MILLWORK, INC.

Quality Architectural
Wood Products

2503 Taylor Street
Omaha, NE 68111

(402) 451-4110

6" Crown Moulding

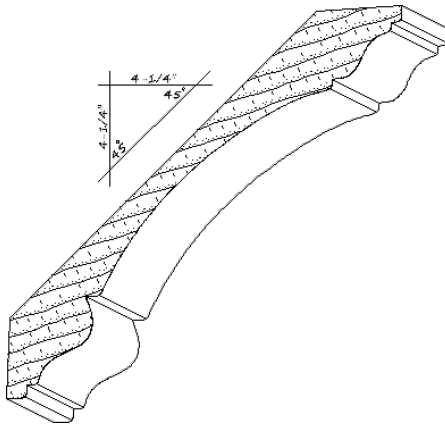

IH-622
3/4 x 6
crown_moulding

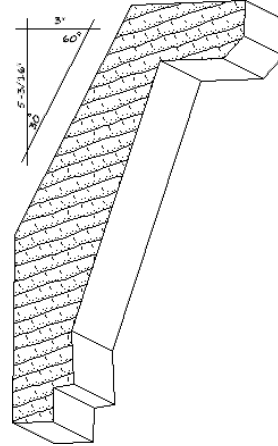

IH-654
1-1/2 x 6
crown_moulding

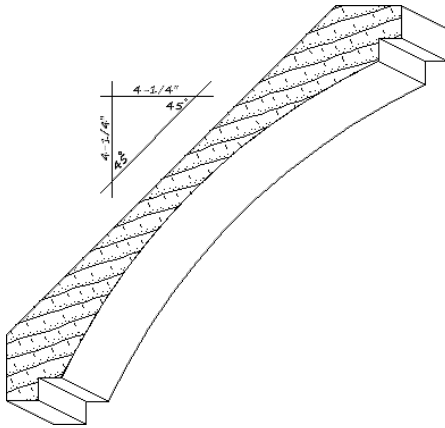

IH-674
3/4 x 6
crown_moulding

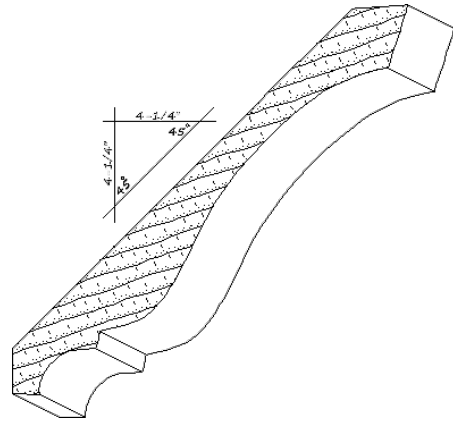

IH-676
3/4 x 6
crown_moulding

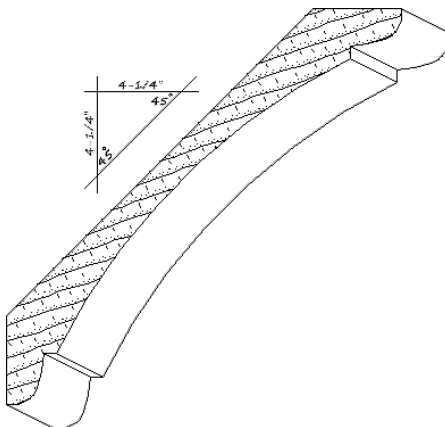

IH-1635
13/16 x 6
crown_moulding

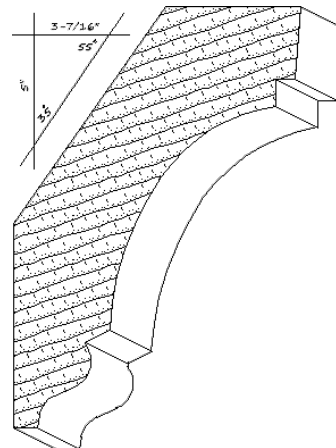

IH-1629
1-3/4 x 6-1/16
crown_moulding



INTEGRITY
ARCHITECTURAL
MILLWORK, INC.

Quality Architectural
Wood Products

2503 Taylor Street
Omaha, NE 68111

(402) 451-4110

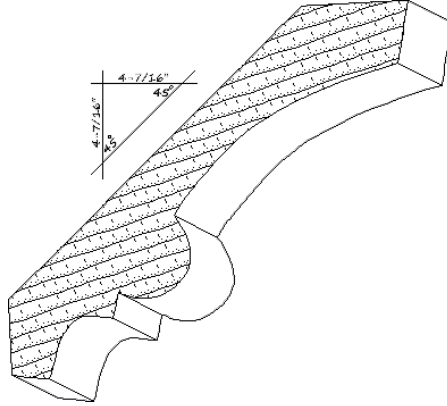

IH-651
1-1/4 x 6-1/4
crown_moulding

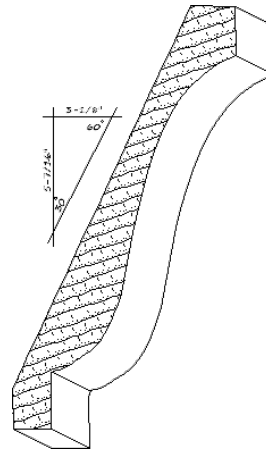

IH-665
13/16 x 6-1/4
crown_moulding

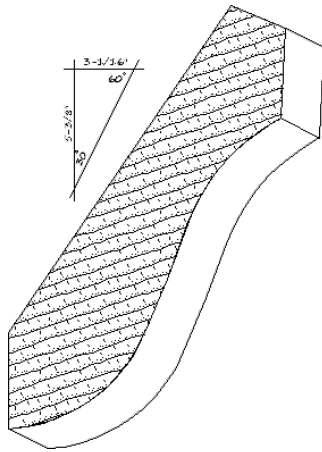

IH-1613
1-1/2 x 6-5/16
crown_moulding

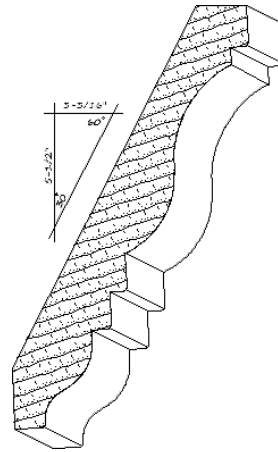

IH-634
15/16 x 6-3/8
crown_moulding

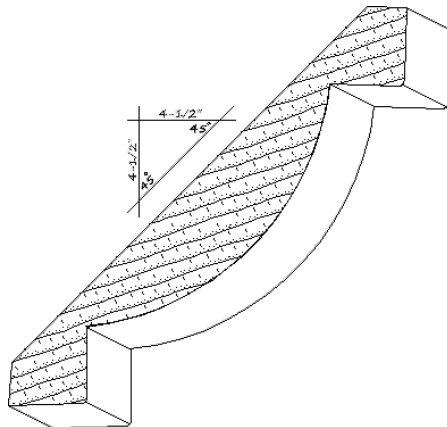

IH-680
1 x 6-3/8
crown_moulding

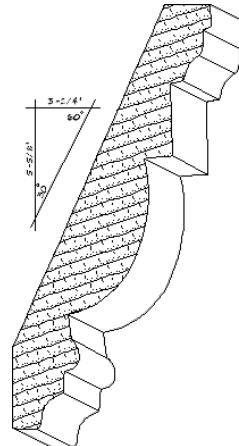

IH-607
1-1/16 x 6-1/2
crown_moulding



INTEGRITY
ARCHITECTURAL
MILLWORK, INC.

Quality Architectural
Wood Products

2503 Taylor Street
Omaha, NE 68111

(402) 451-4110

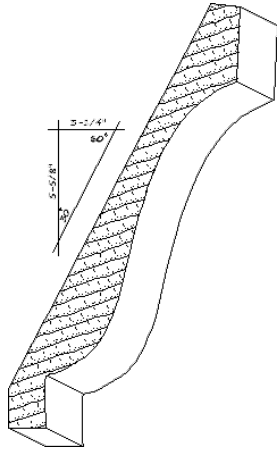

IH-678
13/16 x 6-1/2
crown_moulding

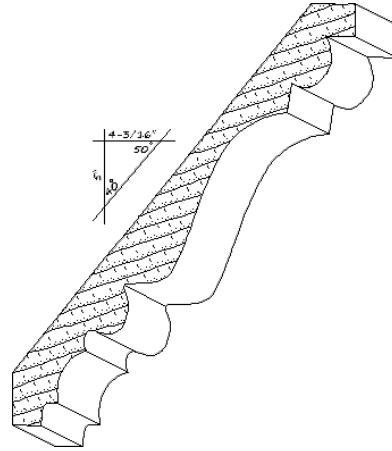

IH-679
3/4 x 6-1/2
crown_moulding

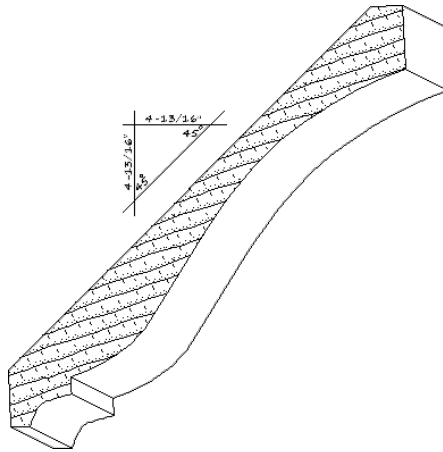

IH-602
13/16 x 6-13/16
crown_moulding

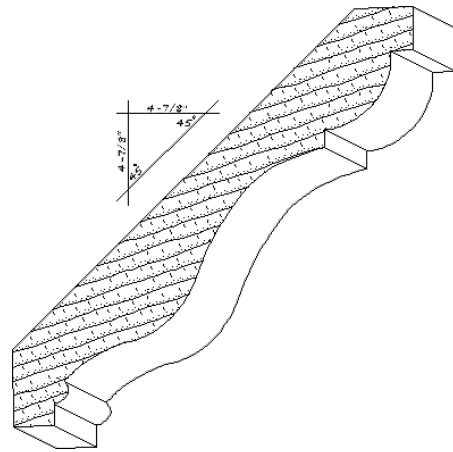

IH-670
1-1/16 x 6-7/8
crown_moulding



INTEGRITY
ARCHITECTURAL
MILLWORK, INC.

Quality Architectural
Wood Products

2503 Taylor Street
Omaha, NE 68111

(402) 451-4110

7+'' Crown Moulding

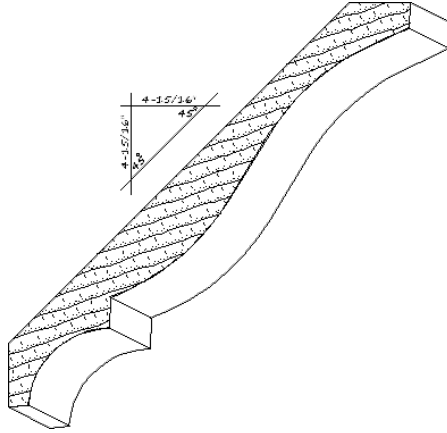

IH-1611
3/4 x 7
crown_moulding

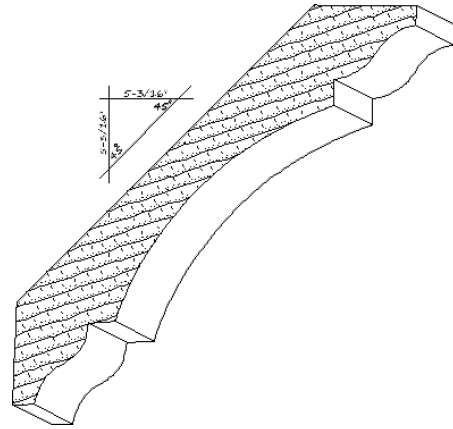

IH-694
1-1/8 x 7-3/8
crown_moulding

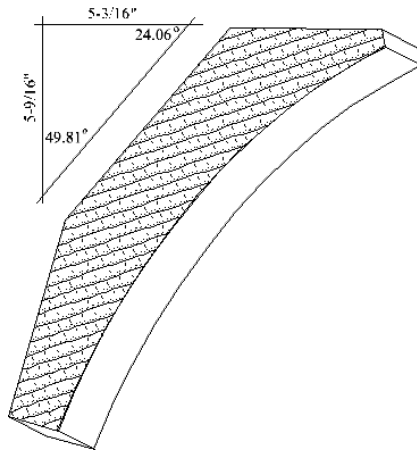

IH-1620
1-13/16 x 7-7/16
crown_moulding

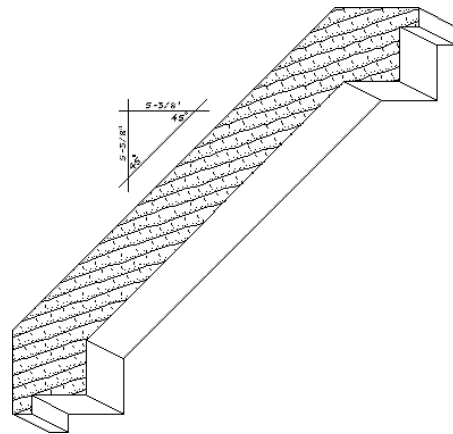

IH-1606
1-5/16 x 7-9/16
crown_moulding

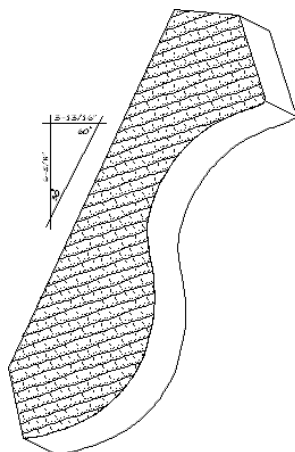

IH-671
1-15/16 x 7-5/8
crown_moulding

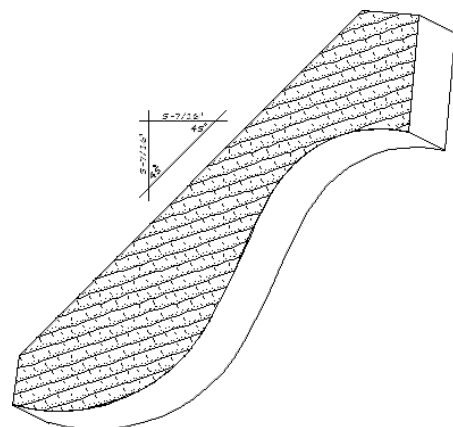

IH-1608
1-5/8 x 7-11/16
crown_moulding



INTEGRITY
ARCHITECTURAL
MILLWORK, INC.

Quality Architectural
Wood Products

2503 Taylor Street
Omaha, NE 68111

(402) 451-4110

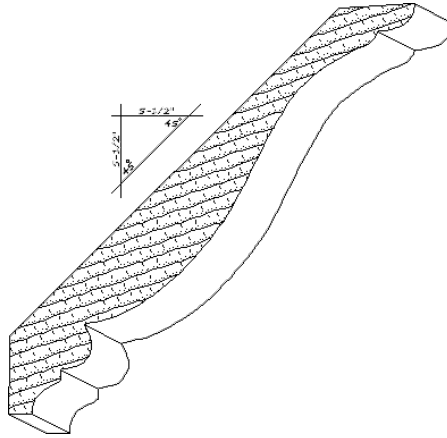

IH-689
1 x 7-3/4
crown_moulding

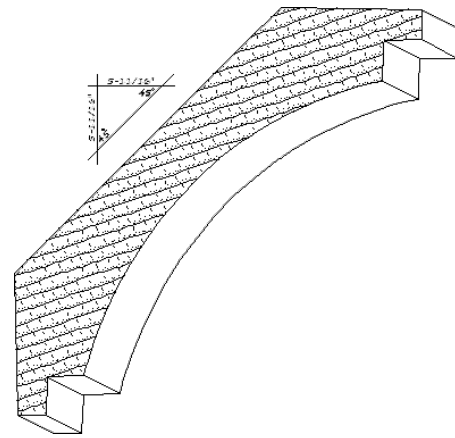

IH-604
1-3/4 x 8
crown_moulding

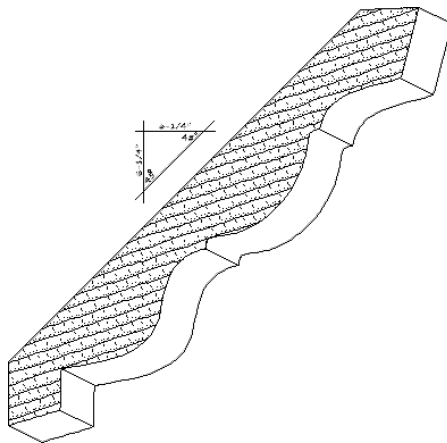

IH-611
1-1/4 x 8-7/8
crown_moulding

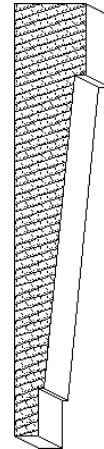

IH-1641
1-1/2 x 9
crown_moulding

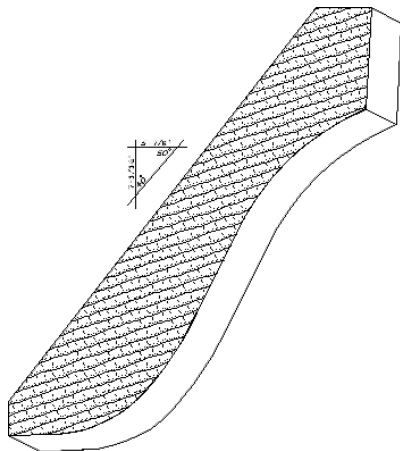

IH-1614
1-11/16 x 9-3/16
crown_moulding

Crown Moulding in the Size, Profile and Species You Need

To discuss your project needs, please call us at (402) 451-4110 or [contact us online](#).



INTEGRITY
ARCHITECTURAL
MILLWORK, INC.

Quality Architectural
Wood Products

2503 Taylor Street
Omaha, NE 68111

(402) 451-4110

Product images are generally to scale but are not shown at actual size.



INTEGRITY
ARCHITECTURAL
MILLWORK, INC.

Quality Architectural
Wood Products

2503 Taylor Street
Omaha, NE 68111

(402) 451-4110



Solid Wood Flooring

If you are an architect or contractor looking for solid wood flooring and want more quality than laminate flooring can offer, we can help! Integrity Architectural Millwork prepares all flooring according to your specifications and keep Maple, Birch, Cherry, Red Oak and Poplar on hand. Hundreds, if not thousands, of other species can also be ordered.

Flooring Profiles

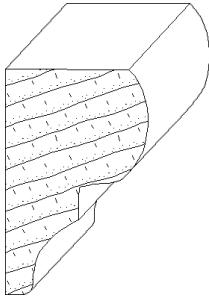

IH-806
1-3/16 x 1-7/8
flooring

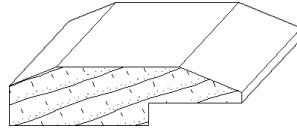

IH-803
3/8 x 2
flooring

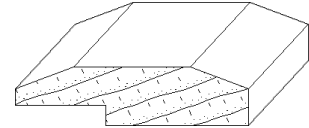

IH-804
1/2 x 2
flooring

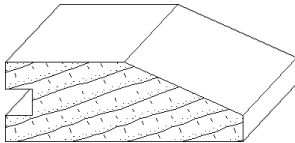

IH-802
3/4 x 2-1/4
flooring

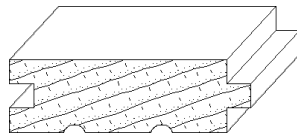

IH-800 (Face)
3/4 x 2-1/4
flooring

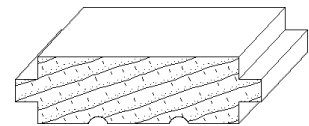

IH-801 (Face)
3/4 x 2-1/4
flooring

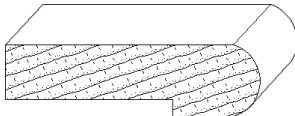

IH-805
1 x 3-1/2
flooring

* Products IH-800, IH-801, IH-802 and IH-805 Can be done in different widths.

Solid Wood Flooring in the Size, Profile and Species You Need

To discuss your project needs, please call us at (402) 451-4110 or [contact us online](#).



INTEGRITY
ARCHITECTURAL
MILLWORK, INC.

Quality Architectural
Wood Products

2503 Taylor Street
Omaha, NE 68111

(402) 451-4110

Product images are generally to scale but are not shown at actual size.



INTEGRITY
ARCHITECTURAL
MILLWORK, INC.

Quality Architectural
Wood Products

2503 Taylor Street
Omaha, NE 68111

(402) 451-4110



Solid Wood Paneling

Integrity Architectural Millwork provides only solid wood paneling – no laminates or plastic paneling here. Our solid wood paneling is prepared according to your specifications. We keep Maple, Birch, Cherry, Red Oak and Poplar on hand, hundreds, if not thousands, of other species can also be ordered.

Sizes: [2 inch](#) | [3 inch](#) | [4 inch](#) | [5 inch](#) | [6 inch](#)

2" Paneling

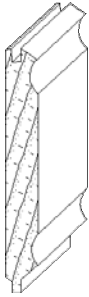

IH-903 (Face)
3/8 x 2-3/4
paneling

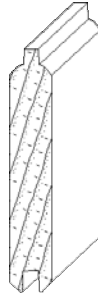

IH-907 (Face)
1/2 x 2-3/4
paneling



INTEGRITY
ARCHITECTURAL
MILLWORK, INC.

Quality Architectural
Wood Products

2503 Taylor Street
Omaha, NE 68111

(402) 451-4110

3" Paneling

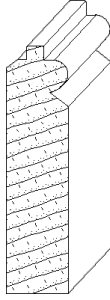

IH-922
3/4 x 3
paneling

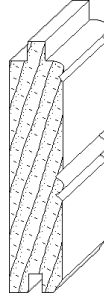

IH-900 (Face)
11/16 x 3
paneling

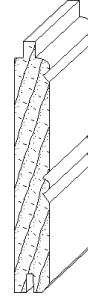

IH-901 (Face)
3/8 x 3
paneling

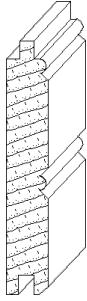

IH-923
9/16 x 3-1/4
paneling



INTEGRITY
ARCHITECTURAL
MILLWORK, INC.

Quality Architectural
Wood Products

2503 Taylor Street
Omaha, NE 68111

(402) 451-4110

4" Paneling

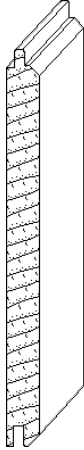

IH-920
3/8 x 4-1/4
paneling



INTEGRITY
ARCHITECTURAL
MILLWORK, INC.

Quality Architectural
Wood Products

2503 Taylor Street
Omaha, NE 68111

(402) 451-4110

5" Paneling

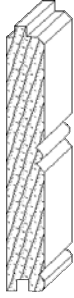

IH-908 (Face)
3/4 x 5
paneling

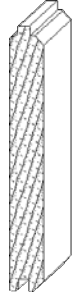

IH-902 (Face)
11/16 x 5-1/4
paneling

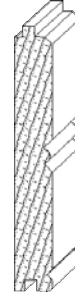

IH-906 (Face)
3/4 x 5-1/4
paneling



INTEGRITY
ARCHITECTURAL
MILLWORK, INC.

Quality Architectural
Wood Products

2503 Taylor Street
Omaha, NE 68111

(402) 451-4110

6" Paneling

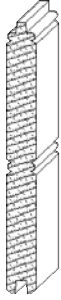

IH-910 (Face)
3/4 x 6-1/4
paneling



IH-911 (Face)
3/4 x 6-7/8
paneling

Paneling in the Size, Profile and Species You Need

To discuss your project needs, please call us at (402) 451-4110 or [contact us online.](#)

Product images are generally to scale but are not shown at actual size.



INTEGRITY
ARCHITECTURAL
MILLWORK, INC.

Quality Architectural
Wood Products

2503 Taylor Street
Omaha, NE 68111

(402) 451-4110



Solid Wood Railings

Integrity Architectural Millwork has rails in a variety of sizes and shapes. All millwork is prepared to your specifications. While we keep Maple, Birch, Cherry, Red Oak and Poplar on hand, hundreds, if not thousands, of other species can also be ordered.

Sizes: [1 inch](#) | [2 inch](#) | [3 inch](#) | [4 inch](#) | [5+ inch](#)

1" Rails

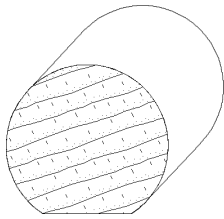

IH-718
1-1/2 x 1-3/8
rails_moulding

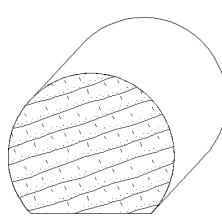

IH-708
1-5/8 x 1-3/8
rails_moulding

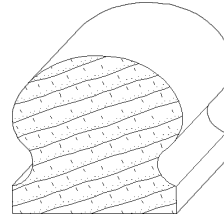

IH-701
1-5/8 x 1-3/4
rails_moulding



INTEGRITY
ARCHITECTURAL
MILLWORK, INC.

Quality Architectural
Wood Products

2503 Taylor Street
Omaha, NE 68111

(402) 451-4110

2" Rails

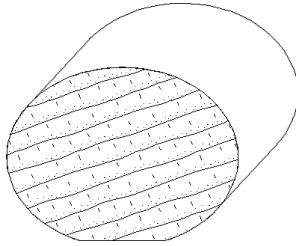

IH-723
1-1/2 x 2
rails_moulding

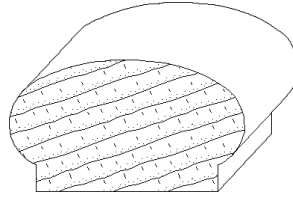

IH-706
1-1/4 x 2-1/4
rails_moulding

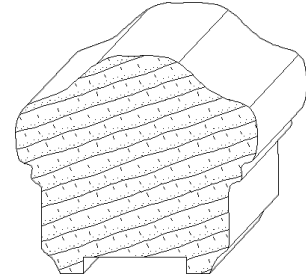

IH-714
2-1/2 x 2-1/4
rails_moulding

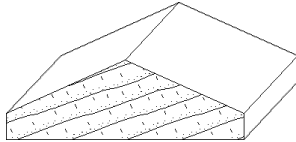

IH-722
3/4 x 2-1/4
rails_moulding

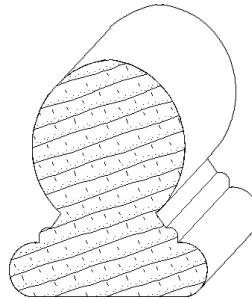

IH-705
2 x 2-3/8
rails_moulding

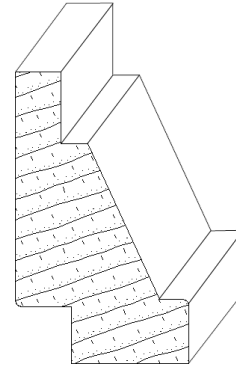

IH-728
1-1/2 x 2-1/2
rails_moulding

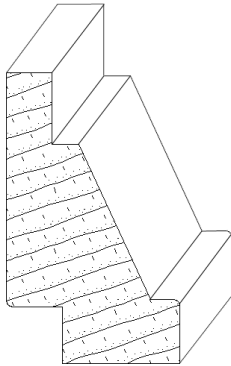

IH-728
1-1/2 x 2-1/2
rails_moulding

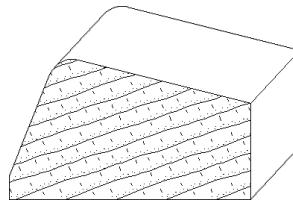

IH-738
1-1/2 x 2-1/2
rails_moulding

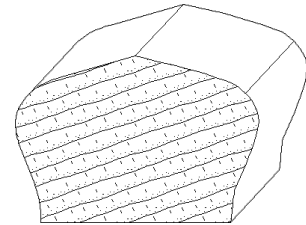

IH-713
1-3/4 x 2-9/16
rails_moulding

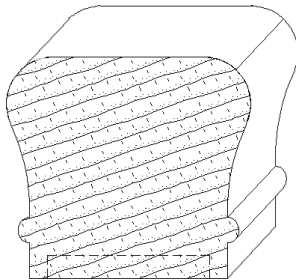

IH-732
2-3/8 x 2-5/8
rails_moulding

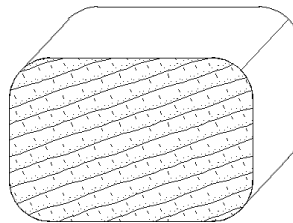

IH-761
1-3/4 x 2-5/8
rails_moulding

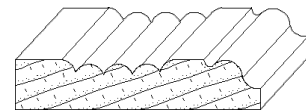

IH-771
9/16 x 2-5/8
rails_moulding



INTEGRITY
ARCHITECTURAL
MILLWORK, INC.

Quality Architectural
Wood Products

2503 Taylor Street
Omaha, NE 68111

(402) 451-4110

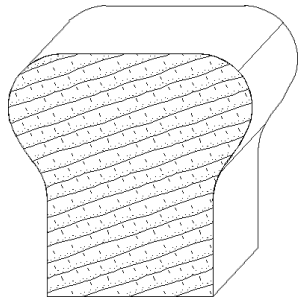

IH-734
2-3/4 x 2-3/4
rails_moulding

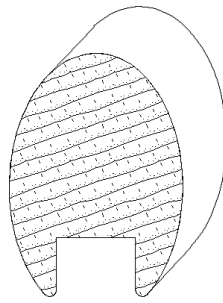

IH-711
2-1/16 x 2-7/8
rails_moulding



INTEGRITY
ARCHITECTURAL
MILLWORK, INC.

Quality Architectural
Wood Products

2503 Taylor Street
Omaha, NE 68111

(402) 451-4110

3" Rails

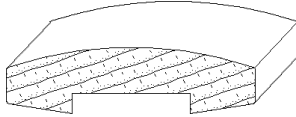

IH-700
3/4 x 3
rails_moulding

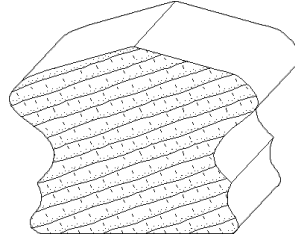

IH-712
2-1/4 x 3
rails_moulding

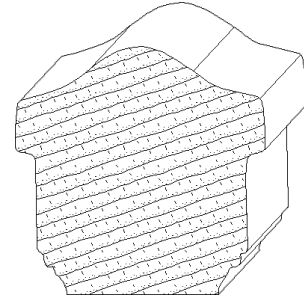

IH-716
3 x 3
rails_moulding

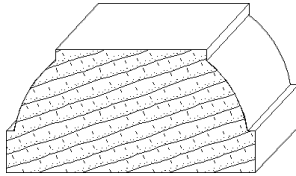

IH-730
3 x 1-1/2
rails_moulding

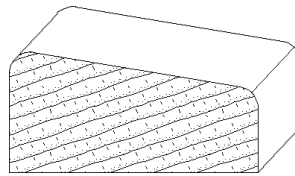

IH-737
1-1/2 x 3
rails_moulding

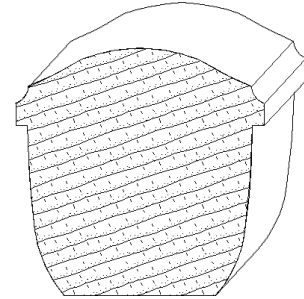

IH-762
3 x 3
rails_moulding

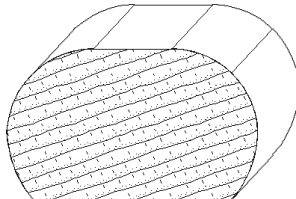

IH-736
1-7/8 x 3-1/8
rails_moulding

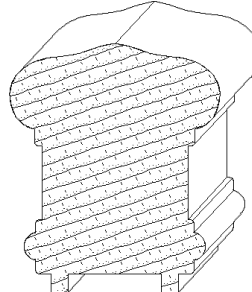

IH-729
2-3/4 x 3-1/4
rails_moulding

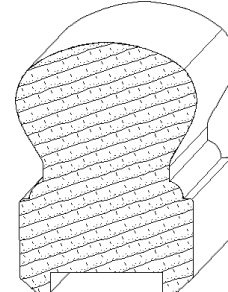

IH-726
2-7/16 x 3-3/8
rails_moulding

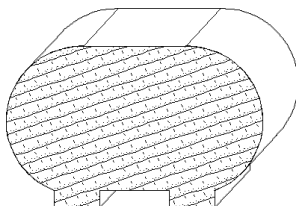

IH-731
2-3/4 x 3-3/8
rails_moulding

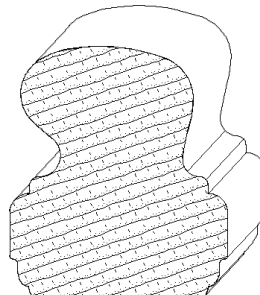

IH-739
2-15/16 x 3-3/8
rails_moulding

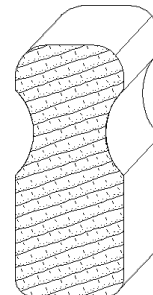

IH-725
1-1/2 x 3-1/2
rails_moulding



INTEGRITY
ARCHITECTURAL
MILLWORK, INC.

Quality Architectural
Wood Products

2503 Taylor Street
Omaha, NE 68111

(402) 451-4110

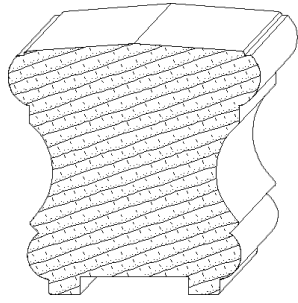

IH-727
3-1/2 x 3-1/2
rails_moulding

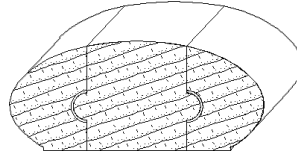

IH-733
1-1/2 x 3-1/2
rails_moulding

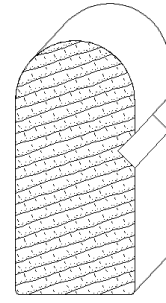

IH-749
1-3/4 x 3-3/4
rails_moulding



INTEGRITY
ARCHITECTURAL
MILLWORK, INC.

Quality Architectural
Wood Products

2503 Taylor Street
Omaha, NE 68111

(402) 451-4110

4" Rails

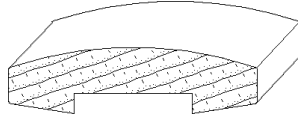

IH-700
3/4 x 3
rails_moulding

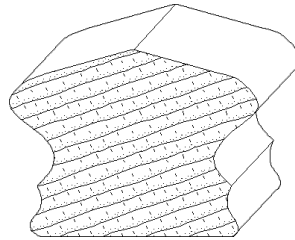

IH-712
2-1/4 x 3
rails_moulding

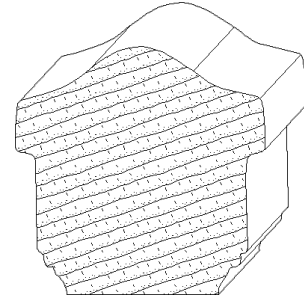

IH-716
3 x 3
rails_moulding

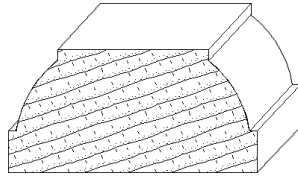

IH-730
3 x 1-1/2
rails_moulding

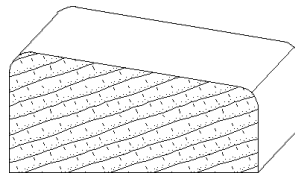

IH-737
1-1/2 x 3
rails_moulding

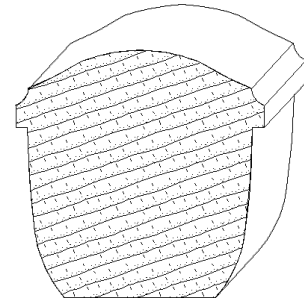

IH-762
3 x 3
rails_moulding

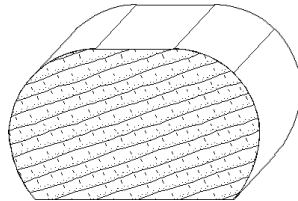

IH-736
1-7/8 x 3-1/8
rails_moulding

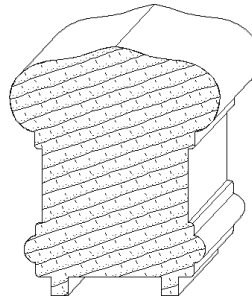

IH-729
2-3/4 x 3-1/4
rails_moulding

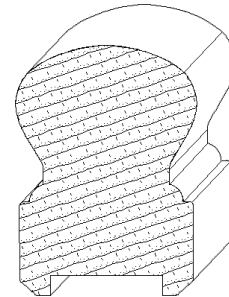

IH-726
2-7/16 x 3-3/8
rails_moulding

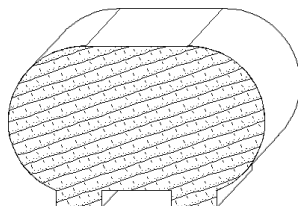

IH-731
2-3/4 x 3-3/8
rails_moulding

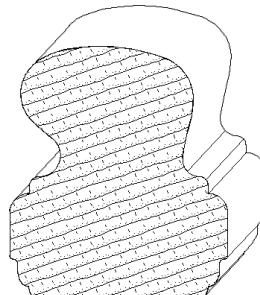

IH-739
2-15/16 x 3-3/8
rails_moulding

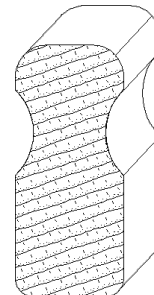

IH-725
1-1/2 x 3-1/2
rails_moulding



INTEGRITY
ARCHITECTURAL
MILLWORK, INC.

Quality Architectural
Wood Products

2503 Taylor Street
Omaha, NE 68111

(402) 451-4110

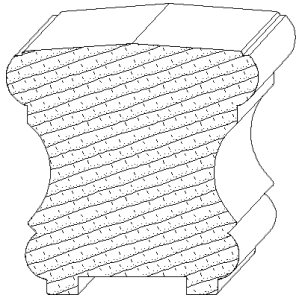

IH-727
3-1/2 x 3-1/2
rails_moulding

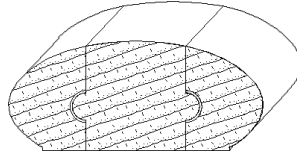

IH-733
1-1/2 x 3-1/2
rails_moulding

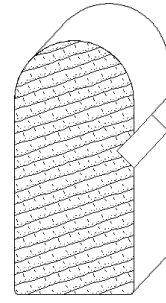

IH-749
1-3/4 x 3-3/4
rails_moulding

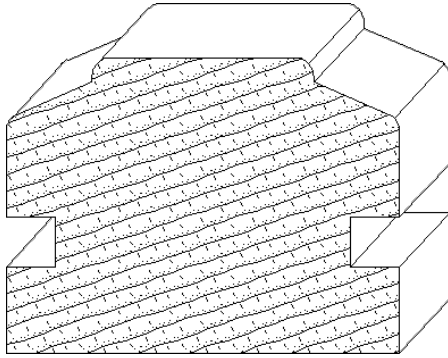

IH-707
3 x 4
rails_moulding

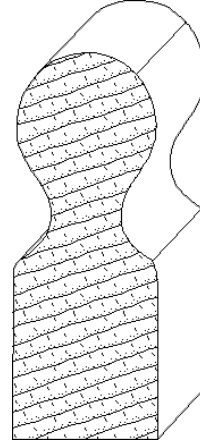

IH-710
1-1/2 x 4
rails_moulding

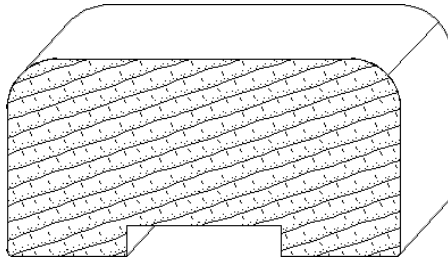

IH-757
2 x 4
rails_moulding

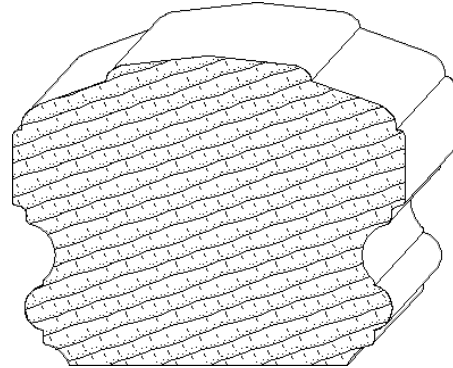

IH-720
3-1/4 x 4-1/8
rails_moulding



INTEGRITY
ARCHITECTURAL
MILLWORK, INC.

Quality Architectural
Wood Products

2503 Taylor Street
Omaha, NE 68111

(402) 451-4110

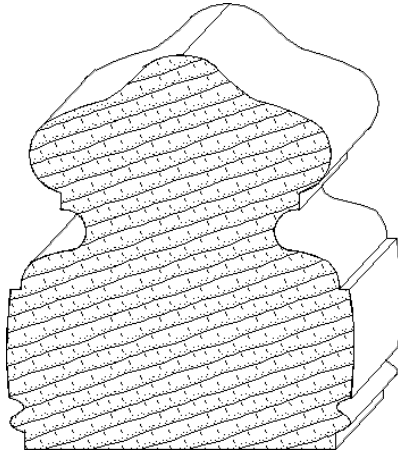

IH-763
3-3/4 x 4-1/4
rails_moulding

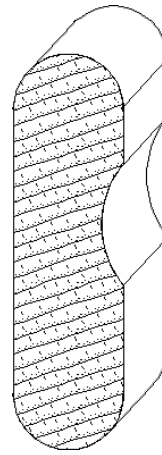

IH-704
1-1/4 x 4-1/2
rails_moulding

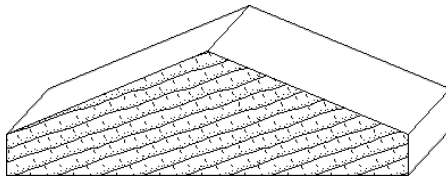

IH-735
1-1/2 x 4-7/8
rails_moulding

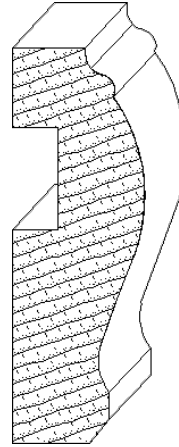

IH-740
1-5/8 x 4-7/8
rails_moulding



INTEGRITY
ARCHITECTURAL
MILLWORK, INC.

Quality Architectural
Wood Products

2503 Taylor Street
Omaha, NE 68111

(402) 451-4110

5+'' Rails

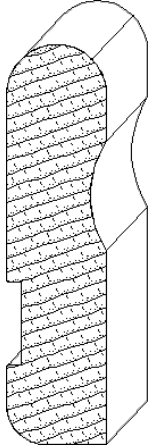

IH-758
1-1/4 x 5
rails_moulding

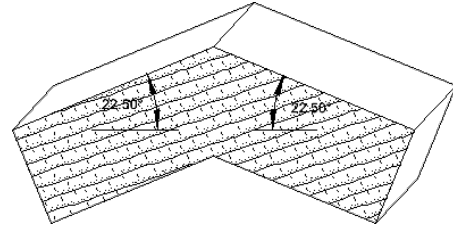

IH-760
2-3/16 x 5
rails_moulding

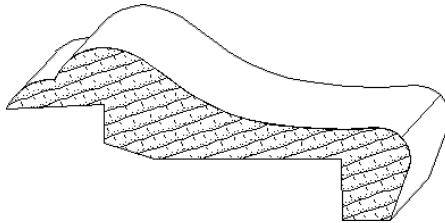

IH-754
2-1/4 x 5-1/4
rails_moulding

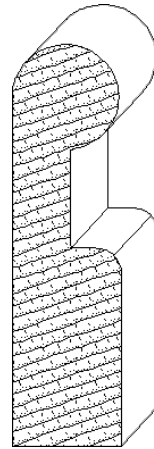

IH-702
1-1/2 x 5-1/2
rails_moulding

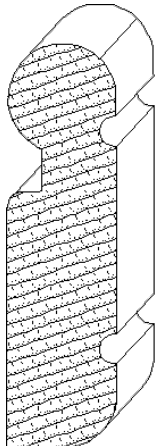

IH-709
1-1/2 x 5-1/2
rails_moulding

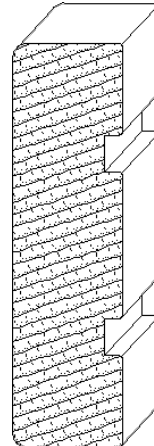

IH-717
1-1/2 x 5-1/2
rails_moulding



INTEGRITY
ARCHITECTURAL
MILLWORK, INC.

Quality Architectural
Wood Products

2503 Taylor Street
Omaha, NE 68111

(402) 451-4110

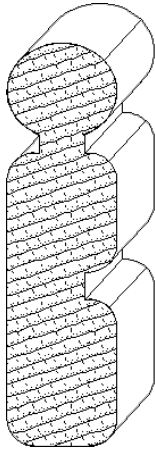

IH-719
1-1/2 x 5-1/2
rails_moulding

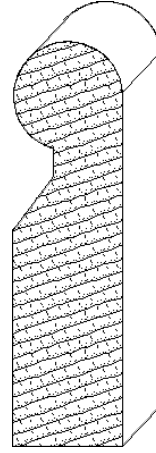

IH-741
1-1/2 x 5-1/2
rails_moulding

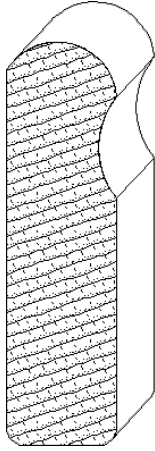

IH-752
1-1/2 x 5-1/2
rails_moulding

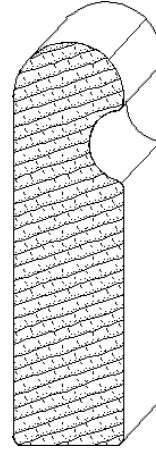

IH-756
1-1/2 x 5-1/2
rails_moulding

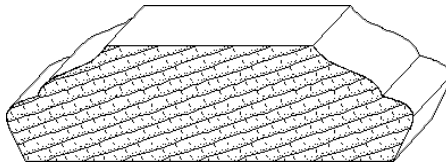

IH-721
1-5/8 x 5-5/8
rails_moulding

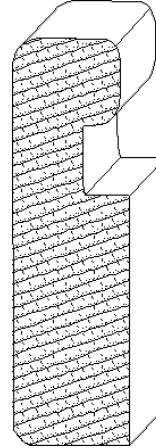

IH-715
1-3/4 x 6
rails_moulding



INTEGRITY
ARCHITECTURAL
MILLWORK, INC.

Quality Architectural
Wood Products

2503 Taylor Street
Omaha, NE 68111

(402) 451-4110

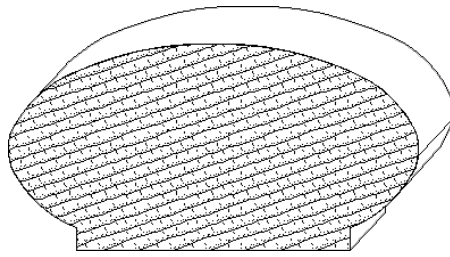

IH-770
3 x 6
rails_moulding

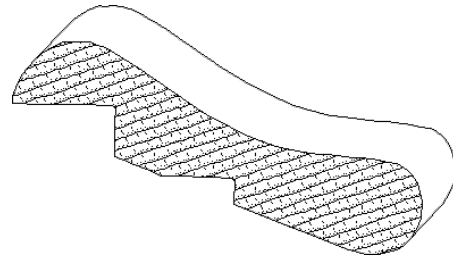

IH-750
1-1/2 x 6-5/8
rails_moulding

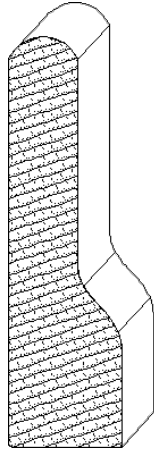

IH-753
1-7/8 x 6-5/8
rails_moulding

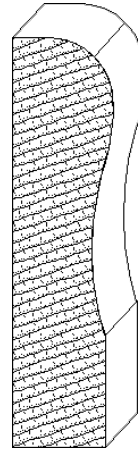

IH-759
1-5/8 x 6-5/8
rails_moulding

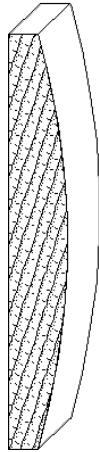

IH-751
1 x 7
rails_moulding

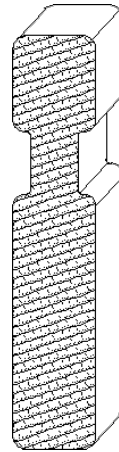

IH-724
1-1/2 x 7-1/2
rails_moulding



INTEGRITY
ARCHITECTURAL
MILLWORK, INC.

Quality Architectural
Wood Products

2503 Taylor Street
Omaha, NE 68111

(402) 451-4110



IH-703
1-1/4 x 8
rails_moulding

Railings in the Size, Profile and Species You Need

To discuss your project needs, please call us at (402) 451-4110 or [contact us online.](#)

Product images are generally to scale but are not shown at actual size.



INTEGRITY
ARCHITECTURAL
MILLWORK, INC.

Quality Architectural
Wood Products

2503 Taylor Street
Omaha, NE 68111

(402) 451-4110



Miscellaneous Mouldings

These are some of the other mouldings we profiles we offer. Integrity Architectural Millwork's moulding options are endless.

We have done custom mouldings for historic renovations and all kinds of interesting projects. Since all millwork is prepared to your specifications, everything we do is custom. If you are an architect or general contractor and need something you don't see on our website, give us a call at (402) 451-4110.

Sizes: Under 1 inch | 1 inch | 1 1/2 inch | 2 inch | 3+ inch

Under 1" Mouldings

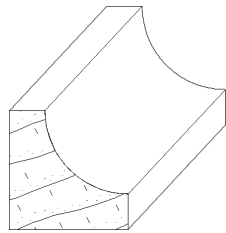

IH-108
5/8 x 5/8
misc_other

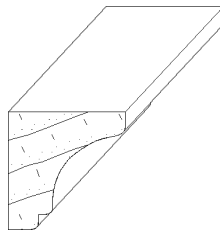

IH-170
5/8 x 5/8
misc_other

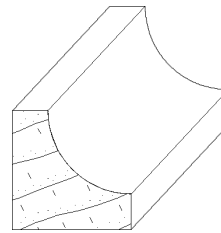

IH-108
5/8 x 5/8
misc_other

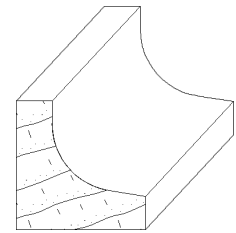

IH-110
3/4 x 3/4
misc_other

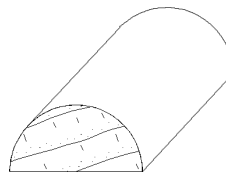

IH-112
3/8 x 3/4
misc_other

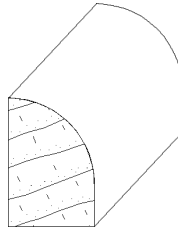

IH-116
1/2 x 3/4
misc_other

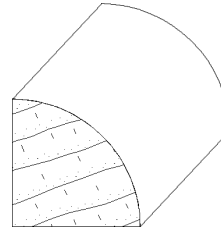

IH-117
3/4 x 3/4
misc_other

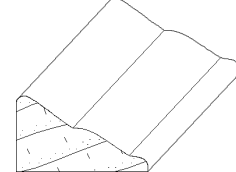

IH-139
7/16 x 3/4
misc_other

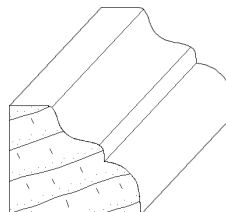

IH-141
5/8 x 3/4
misc_other

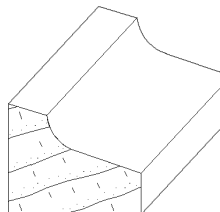

IH-147
5/8 x 3/4
misc_other

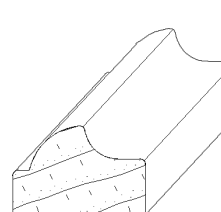

IH-152
1/2 x 3/4
misc_other

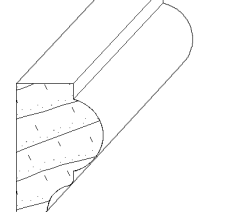

IH-178
1/2 x 3/4
misc_other



INTEGRITY
ARCHITECTURAL
MILLWORK, INC.

Quality Architectural
Wood Products

2503 Taylor Street
Omaha, NE 68111

(402) 451-4110

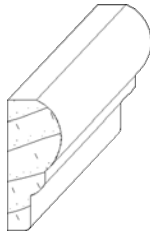

IH-186
5/16 x 3/4
misc_other

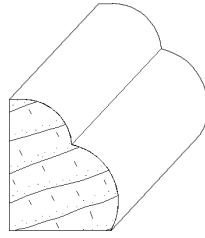

IH-1021
5/8 x 3/4
misc_other

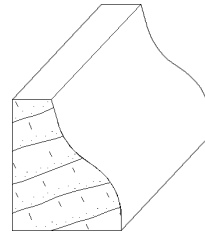

IH-1029
5/8 x 3/4
misc_other

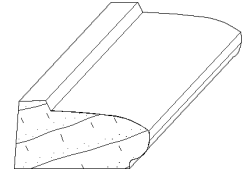

IH-1042
3/8 x 3/4
misc_other

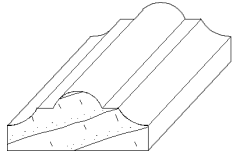

IH-101
3/8 x 7/8
misc_other

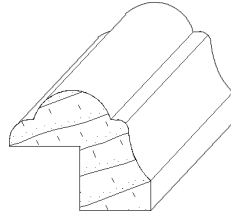

IH-132
3/4 x 7/8
misc_other

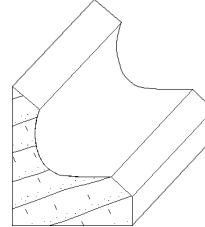

IH-1035
3/4 x 7/8
misc_other

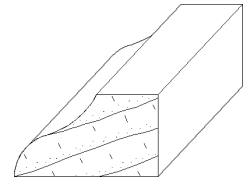

IH-1075
1/2 x 7/8
misc_other

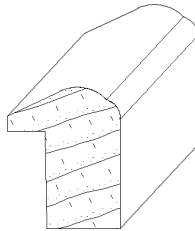

IH-129
3/4 x 15/16
misc_other

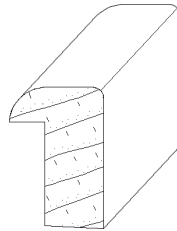

IH-143
5/8 x 15/16
misc_other

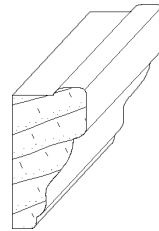

IH-153
1/2 x 15/16
misc_other

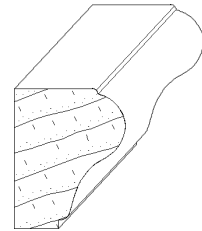

IH-163
3/4 x 15/16
misc_other

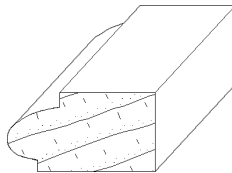

IH-1084
1/2 x 15/16
misc_other

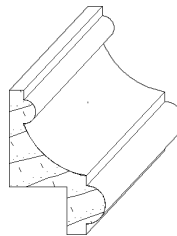

IH-1086
5/8 x 15/16
misc_other



INTEGRITY
ARCHITECTURAL
MILLWORK, INC.

Quality Architectural
Wood Products

2503 Taylor Street
Omaha, NE 68111

(402) 451-4110

1" Mouldings

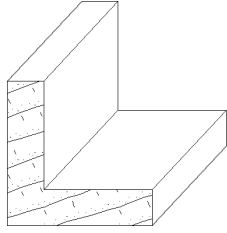

IH-103
1 x 1
misc_other

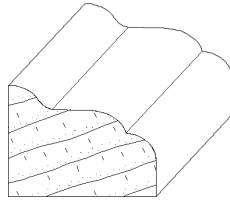

IH-122
3/4 x 1
misc_other

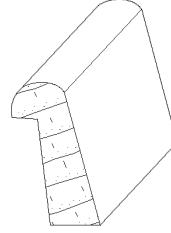

IH-171
1/2 x 1
misc_other

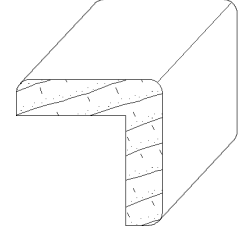

IH-179
1 x 1
misc_other

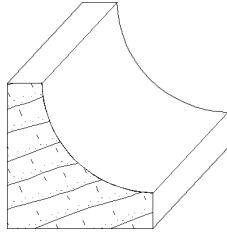

IH-183
1 x 1
misc_other

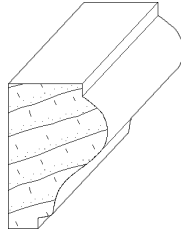

IH-185
11/16 x 1
misc_other

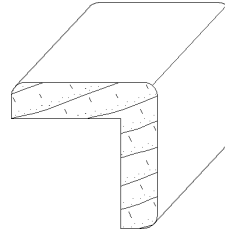

IH-188
1 x 1
misc_other

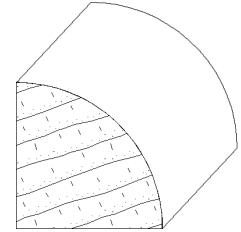

IH-190
1 x 1
misc_other

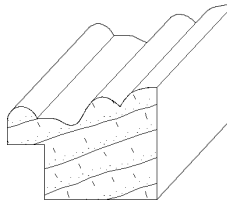

IH-192
3/4 x 1
misc_other

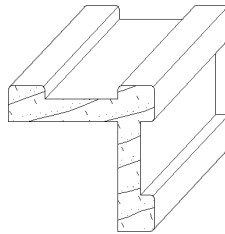

IH-193
1 x 1
misc_other

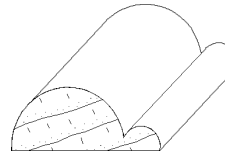

IH-194
7/16 x 1
misc_other

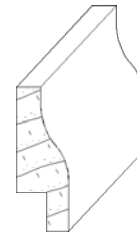

IH-1026
3/8 x 1
misc_other

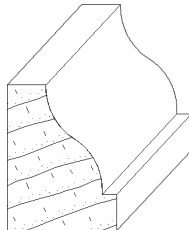

IH-1032
3/4 x 1
misc_other

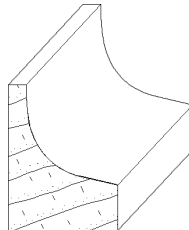

IH-1033
3/4 x 1
misc_other

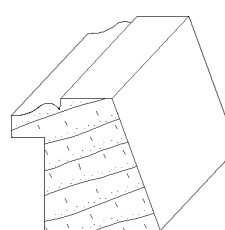

IH-1034
7/8 x 1
misc_other

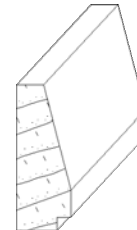

IH-1040
3/8 x 1
misc_other

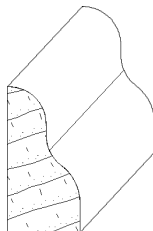

IH-1062
1/2 x 1
misc_other

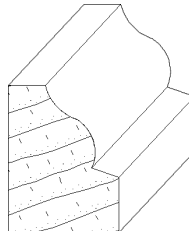

IH-1085
3/4 x 1
misc_other

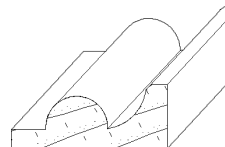

IH-1079
7/16 x 1-1/8
misc_other

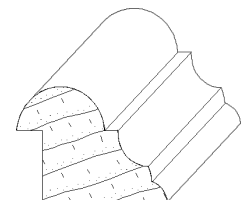

IH-120
13/16 x 1-1/16
misc_other



INTEGRITY
ARCHITECTURAL
MILLWORK, INC.

Quality Architectural
Wood Products

2503 Taylor Street
Omaha, NE 68111

(402) 451-4110

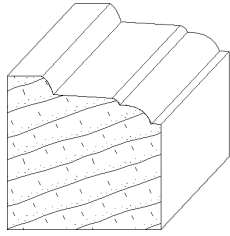

IH-165
1-1/16 x 1-1/16
misc_other

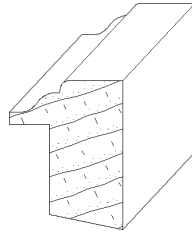

IH-174
13/16 x 1-1/16
misc_other

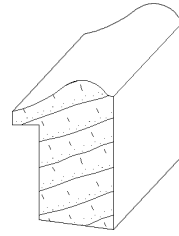

IH-1007
3/4 x 1-1/16
misc_other

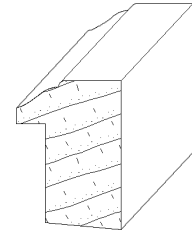

IH-1017
3/4 x 1-1/16
misc_other

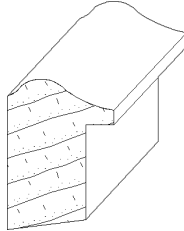

IH-1036
3/4 x 1-1/16
misc_other

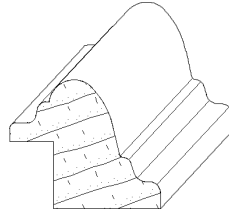

IH-1060
15/16 x 1-1/16
misc_other

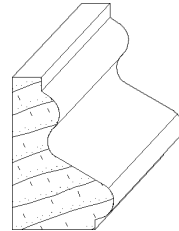

IH-102
3/4 x 1-1/8
misc_other

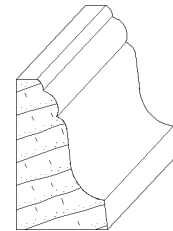

IH-126
11/16 x 1-1/8
misc_other

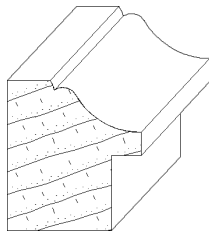

IH-131
1 x 1-1/8
misc_other

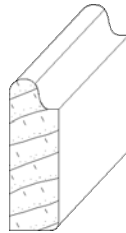

IH-138
3/8 x 1-1/8
misc_other

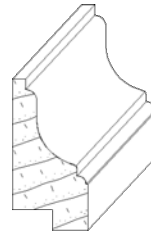

IH-154
9/16 x 1-1/8
misc_other

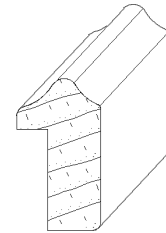

IH-156
5/8 x 1-1/8
misc_other

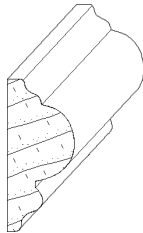

IH-157
1/2 x 1-1/8
misc_other

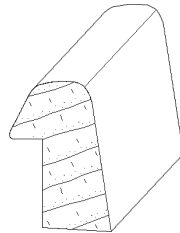

IH-184
5/8 x 1-1/8
misc_other

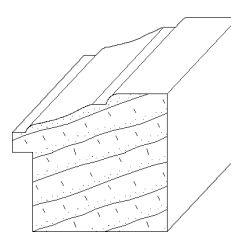

IH-198
1 x 1-1/8
misc_other

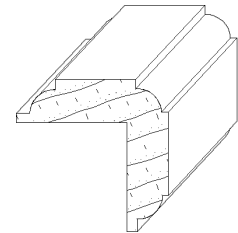

IH-1024
1-1/8 x 1-1/8
misc_other

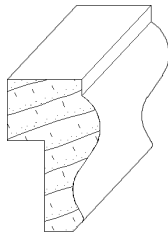

IH-1053
11/16 x 1-1/8
misc_other

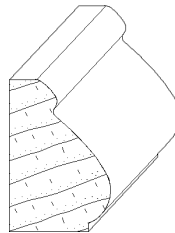

IH-1056
3/4 x 1-1/8
misc_other

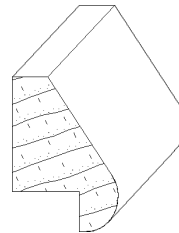

IH-144
13/16 x 1-3/16
misc_other

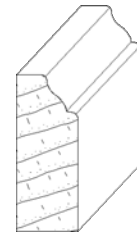

IH-162
1 x 1-3/16
misc_other



INTEGRITY
ARCHITECTURAL
MILLWORK, INC.

Quality Architectural
Wood Products

2503 Taylor Street
Omaha, NE 68111

(402) 451-4110

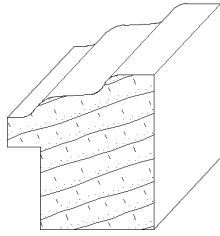

IH-1054
1-1/8 x 1-3/16
misc_other

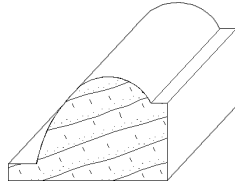

IH-1078
3/4 x 1-3/16
misc_other

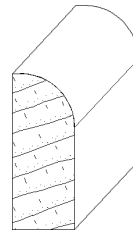

IH-107
1/2 x 1-1/4
misc_other

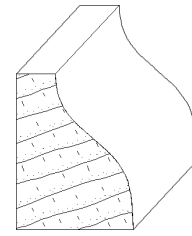

IH-109
15/16 x 1-1/4
misc_other

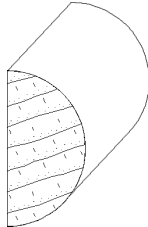

IH-113
5/8 x 1-1/4
misc_other

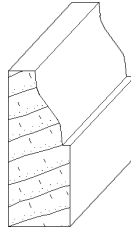

IH-124
1/2 x 1-1/4
misc_other

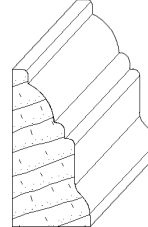

IH-133
5/8 x 1-1/4
misc_other

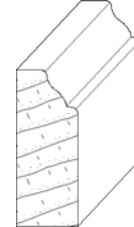

IH-161
1/2 x 1-1/4
misc_other

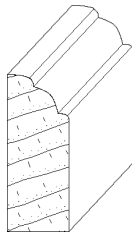

IH-166
1/2 x 1-1/4
misc_other

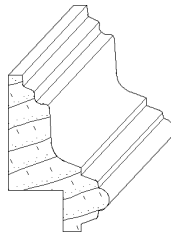

IH-169
13/16 x 1-1/4
misc_other

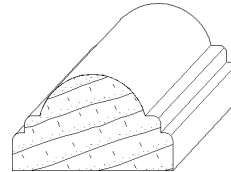

IH-177
3/4 x 1-1/4
misc_other

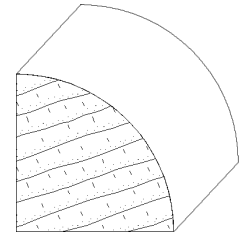

IH-181
1-1/4 x 1-1/4
misc_other

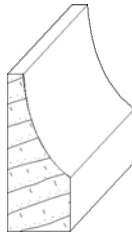

IH-1041
1/2 x 1-1/4
misc_other

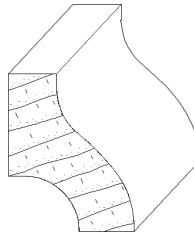

IH-1043
1 x 1-1/4
misc_other

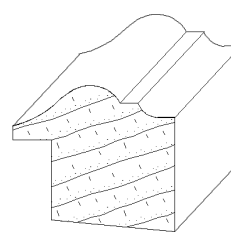

IH-1068
1-1/8 x 1-1/4
misc_other

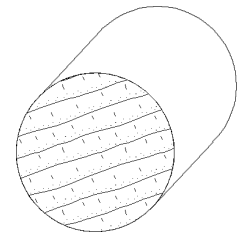

IH-121
1-5/16 x 1-5/16
misc_other

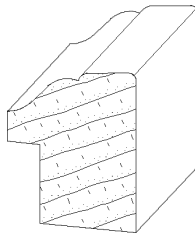

IH-173
1-1/16 x 1-5/16
misc_other

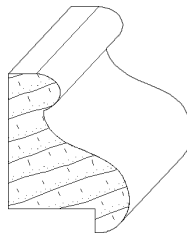

IH-187
1 x 1-5/16
misc_other

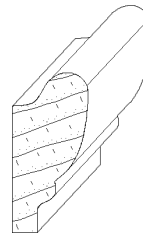

IH-189
5/8 x 1-5/16
misc_other

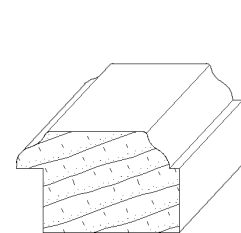

IH-1051
13/16 x 1-5/16
misc_other



INTEGRITY
ARCHITECTURAL
MILLWORK, INC.

Quality Architectural
Wood Products

2503 Taylor Street
Omaha, NE 68111

(402) 451-4110

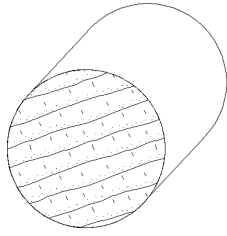

IH-1058
1-5/16 x 1-5/16
misc_other

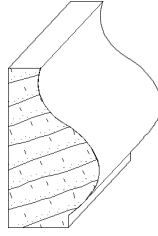

IH-1059
3/4 x 1-5/16
misc_other

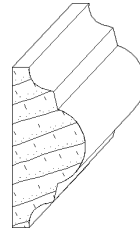

IH-104
5/8 x 1-3/8
misc_other

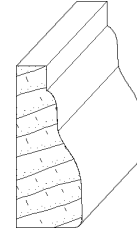

IH-134
9/16 x 1-3/8
misc_other

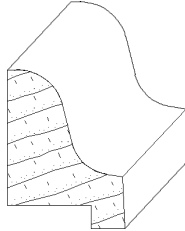

IH-168
1 x 1-3/8
misc_other

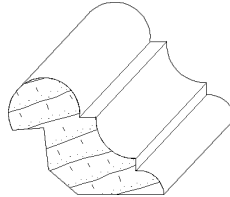

IH-195
1/2 x 1-3/8
misc_other

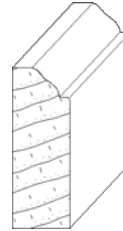

IH-1018
1/2 x 1-3/8
misc_other

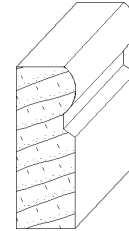

IH-1039
1/2 x 1-3/8
misc_other

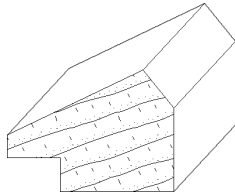

IH-1072
1 x 1-3/8
misc_other

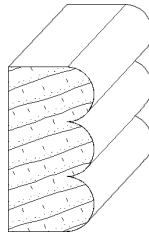

IH-1049
3/4 x 1-7/16
misc_other



INTEGRITY
ARCHITECTURAL
MILLWORK, INC.

Quality Architectural
Wood Products

2503 Taylor Street
Omaha, NE 68111

(402) 451-4110

1 1/2" Mouldings

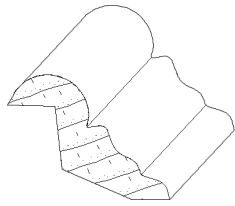

IH-105
11/16 x 1-1/2
misc_other

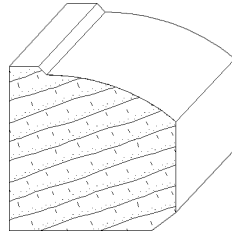

IH-111
1-1/2 x 1-1/2
misc_other

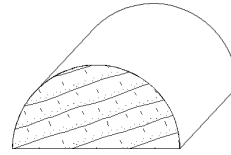

IH-114
3/4 x 1-1/2
misc_other

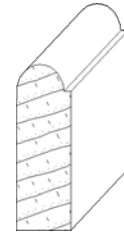

IH-123
1/2 x 1-1/2
misc_other

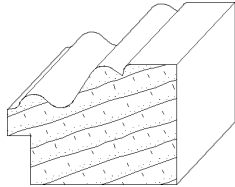

IH-136
1-1/16 x 1-1/2
misc_other

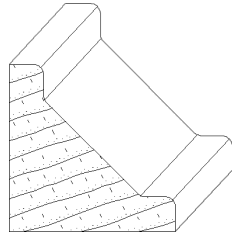

IH-159
1-1/2 x 1-1/2
misc_other

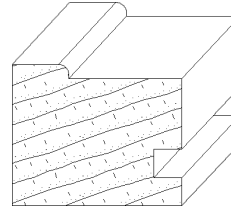

IH-191
1-1/4 x 1-1/2
misc_other



IH-199
1/2 x 1-1/2
misc_other

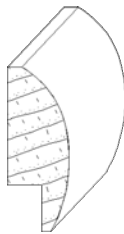

IH-1057
9/16 x 1-1/2
misc_other

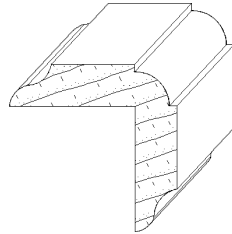

IH-1087
1-1/2 x 1-1/2
misc_other

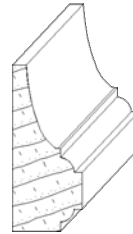

IH-1089
5/8 x 1-1/2
misc_other

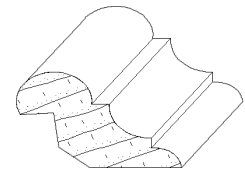

IH-197
5/8 x 1-9/16
misc_other

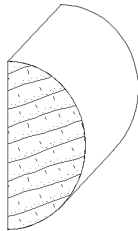

IH-146
3/4 x 1-5/8
misc_other

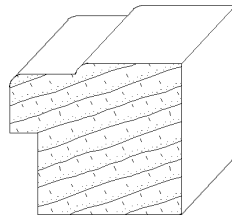

IH-1047
1-7/16 x 1-5/8
misc_other

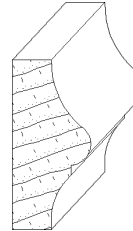

IH-1069
3/4 x 1-5/8
misc_other

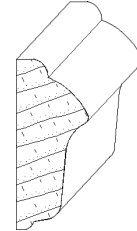

IH-1070
11/16 x 1-5/8
misc_other

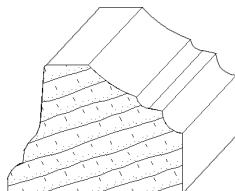

IH-1073
1-1/4 x 1-5/8
misc_other

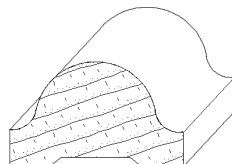

IH-119
1-1/16 x 1-3/4
misc_other



IH-135
3/4 x 1-3/4
misc_other

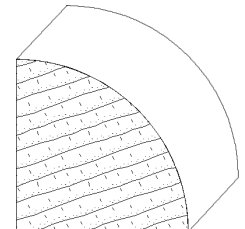

IH-149
1-3/4 x 1-3/4
misc_other



INTEGRITY
ARCHITECTURAL
MILLWORK, INC.

Quality Architectural
Wood Products

2503 Taylor Street
Omaha, NE 68111

(402) 451-4110

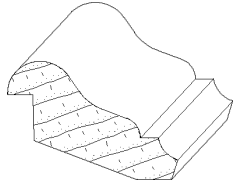

IH-151
3/4 x 1-3/4
misc_other

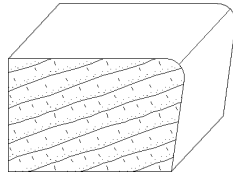

IH-164
1-1/8 x 1-3/4
misc_other

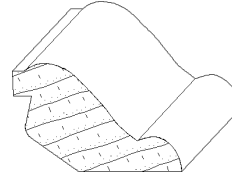

IH-172
3/4 x 1-3/4
misc_other

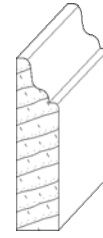

IH-175
7/16 x 1-3/4
misc_other

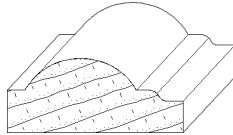

IH-196
3/4 x 1-3/4
misc_other

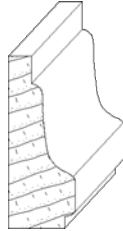

IH-1019
11/16 x 1-3/4
misc_other



IH-176
11/16 x 1-13/16
misc_other

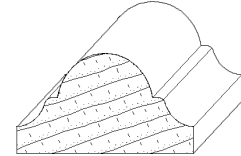

IH-118
1-1/16 x 1-7/8
misc_other

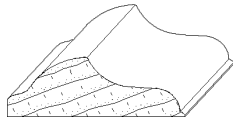

IH-125
5/8 x 1-7/8
misc_other

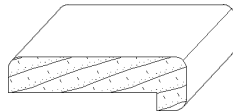

IH-142
9/16 x 1-7/8
misc_other

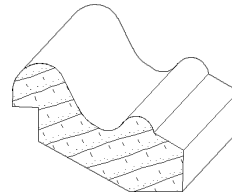

IH-158
11/16 x 1-7/8
misc_other

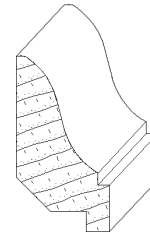

IH-1063
1 x 1-7/8
misc_other

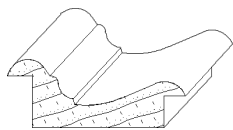

IH-128
3/4 x 1-15/16
misc_other

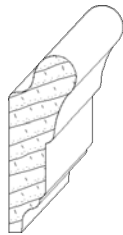

IH-1020
3/4 x 1-15/16
misc_other

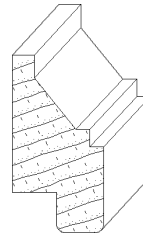

IH-1044
1 x 1-15/16
misc_other

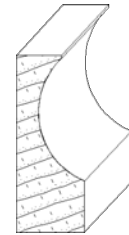

IH-1055
3/4 x 1-15/16
misc_other



INTEGRITY
ARCHITECTURAL
MILLWORK, INC.

Quality Architectural
Wood Products

2503 Taylor Street
Omaha, NE 68111

(402) 451-4110

2" Mouldings

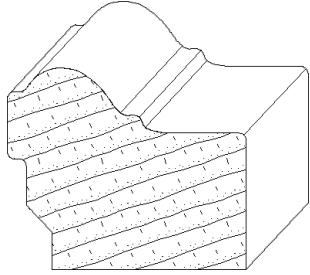

IH-100
1-11/16 x 2
misc_other

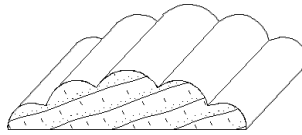

IH-106
1/2 x 2
misc_other

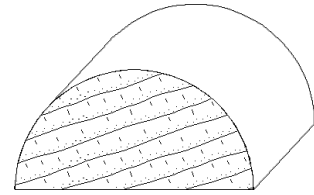

IH-115
1 x 2
misc_other

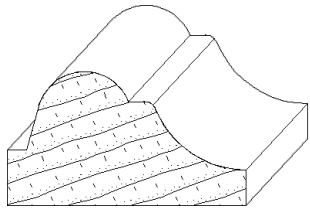

IH-160
1-1/8 x 2
misc_other

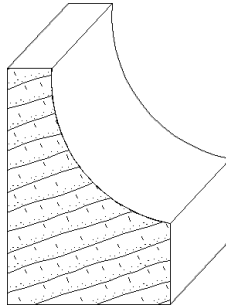

IH-1038
1-3/8 x 2
misc_other

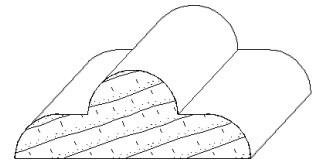

IH-1061
3/4 x 2
misc_other

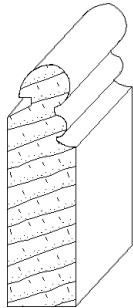

IH-1083
5/8 x 2-3/16
misc_other

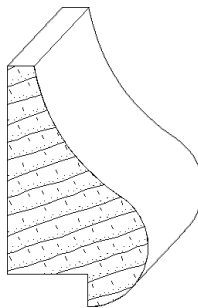

IH-1045
1-5/16 x 2-1/4
misc_other

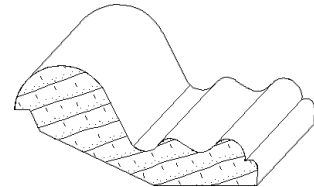

IH-145
11/16 x 2-5/16
misc_other

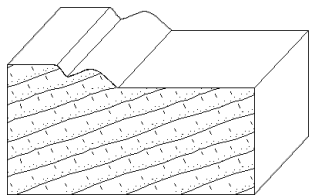

IH-1050
1-1/4 x 2-3/8
misc_other

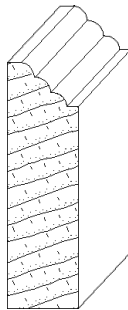

IH-1071
11/16 x 2-3/8
misc_other

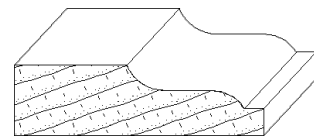

IH-127
11/16 x 2-7/16
misc_other



INTEGRITY
ARCHITECTURAL
MILLWORK, INC.

Quality Architectural
Wood Products

2503 Taylor Street
Omaha, NE 68111

(402) 451-4110

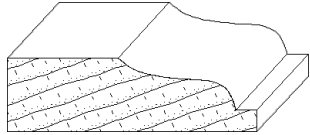

IH-150
3/4 x 2-1/2
misc_other

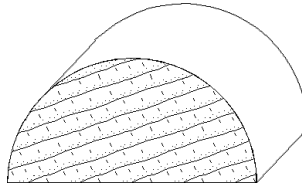

IH-180
1-1/4 x 2-1/2
misc_other



INTEGRITY
ARCHITECTURAL
MILLWORK, INC.

Quality Architectural
Wood Products

2503 Taylor Street
Omaha, NE 68111

(402) 451-4110

3"+ Mouldings

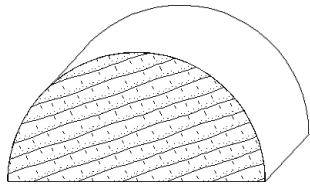

IH-130
1-1/2 x 3
misc_other

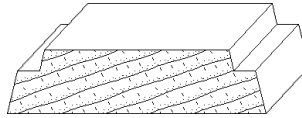

IH-1004
3/4 x 3-1/16
misc_other

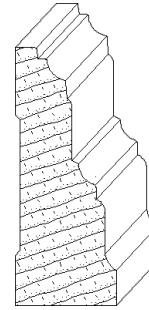

IH-1065
1-1/4 x 3-1/16
misc_other

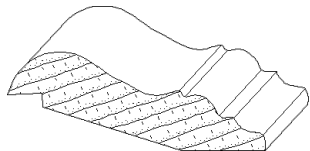

IH-155
3/4 x 3-3/16
misc_other

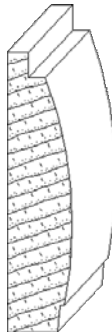

IH-1028
9/16 x 3-1/4
misc_other

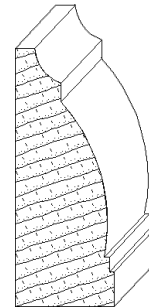

IH-1046
1-1/4 x 3-1/4
misc_other

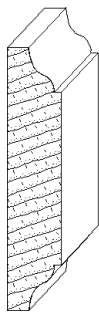

IH-1007
3/4 x 3-5/8
misc_other

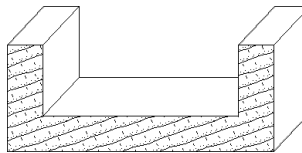

IH-1025
1-1/2 x 3-3/4
misc_other

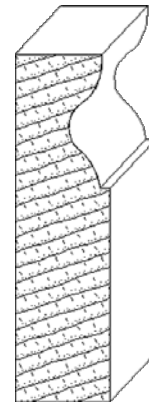

IH-1031-A
1-1/16 x 3-15/16
misc_other



INTEGRITY
ARCHITECTURAL
MILLWORK, INC.

Quality Architectural
Wood Products

2503 Taylor Street
Omaha, NE 68111

(402) 451-4110

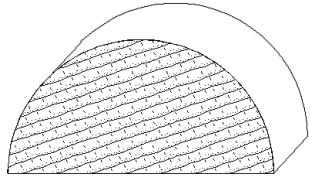

IH-140
2 x 4
misc_other

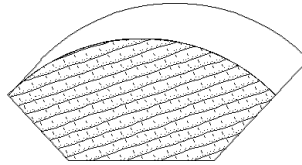

IH-137
1-7/8 x 4-1/8
misc_other



IH-1122
1 x 4-1/2
misc_other

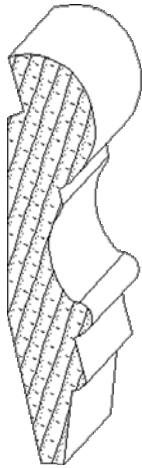

IH-182
1 x 4-9/16
misc_other

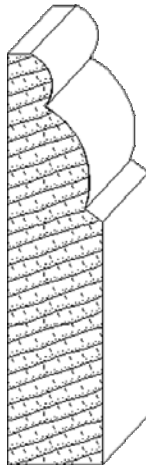

IH-1031-B
1-1/16 x 4-9/16
misc_other

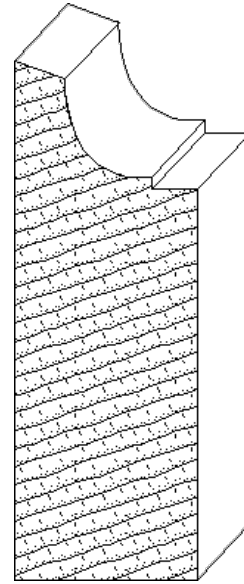

IH-1081
1-3/4 x 5
misc_other



INTEGRITY
ARCHITECTURAL
MILLWORK, INC.

Quality Architectural
Wood Products

2503 Taylor Street
Omaha, NE 68111

(402) 451-4110

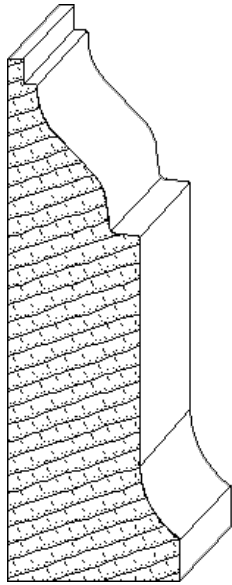

IH-1080
1-3/4 x 5-5/16
misc_other

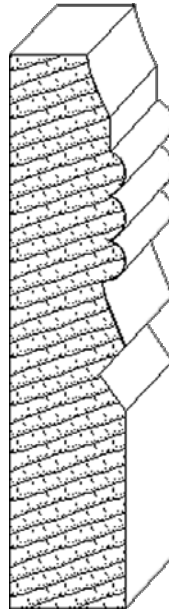

IH-1030
1-1/4 x 6
misc_other

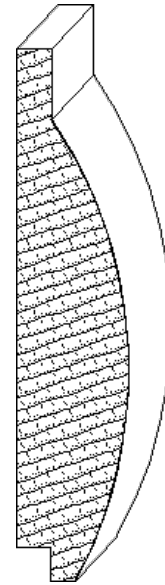

IH-1008
1-3/8 x 6-1/2
misc_other

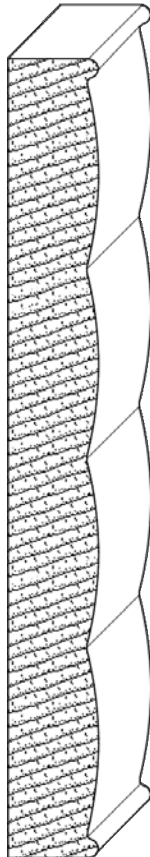

IH-1121
1 x 8-1/2
misc_other

The Moulding in the Size, Profile and Species You Need

To discuss your project needs, please call us at (402) 451-4110 or [contact us online](#).



INTEGRITY
ARCHITECTURAL
MILLWORK, INC.

Quality Architectural
Wood Products

2503 Taylor Street
Omaha, NE 68111

(402) 451-4110

Product images are generally to scale but are not shown at actual size.
